

# DECUSCOPE

## INFORMATION FOR DIGITAL EQUIPMENT COMPUTER USERS

January 1965

Volume 4 Number 1

### LINC DEMONSTRATION IN COPENHAGEN

Recently, Mr. Morton Ruderman of Digital Equipment Corporation attended a demonstration of the LINC computer in Copenhagen. The following are brief descriptions of several of the programs that were demonstrated.

The presentation was opened by a few words on the philosophy of design and the history of the LINC and its development at M.I.T., the features of the LINC tape, A to D and D to A and the relay controls. A demonstration of the number of ways to enter the machine either through the keyboard, the toggle switches or data terminal box followed.

First to be demonstrated was the GUIDE Utility Program. In general, this utility systems program enables one to very easily store any programs on tape, to call for all existing programs at the keyboard, up-date or modify, or to perform a number of different manipulations right at the keyboard with everything instantaneously displayed on the oscilloscope.

Secondly, the Basilar Membrane Program during which a mathematical model of the effect of sound on the basilar membrane was performed. By having this model displayed on the oscilloscope, one was able to determine, with a cursor, the phase shift of the basilar membrane as the frequency or amplitude is varied any place along the membrane.

Next, was the Cursor Program where any data stored away on tape or in memory could be called for such as EKG or any particular analog input which would be immediately displayed on the oscilloscope. A cursor is now available so that you can position it at any point on the curve and identify its relative amplitude.

The Fourier Analysis Program followed, where again one could take any information such as EKG's, store them on tape or in memory and then display it on the oscilloscope and immediately get the frequency distribution of the input. The information crosses the scope from left to right and in left-hand portion of the display scope would immediately appear a bargraph of the relative frequency distribution of the particular wave form. Also, the scope display may be frozen at any point.

### ENGINEERING PROJECT SCHEDULING SYSTEM

By: Robert Vernon, M.I.T. Student/Digital Equipment Corporation

#### Introduction

Digital Equipment Corporation is implementing an engineering project scheduling system to help solve the coordination problems associated with project development.

The typical engineering development project encompasses several phases including design, drafting, production, programming, and publications. Thus a firm, organized on a project basis, requires coordination of these various functions. The project engineer must know the work schedule in each department in order to schedule his project, and the supporting departments must be given estimates of the work requirements associated with each project in order to estimate their manpower requirements and work schedules. DEC's new scheduling system, discussed below, utilizes in-house computing facilities to achieve this coordination.

#### The System

The Project Scheduling System is an engineering planning guide with an automated updating feature. The purpose of the system is to coordinate the engineering effort, both internally and with the various service departments of the Company.

Specifically, the system will:

1. Serve as a planning guide to the engineer by helping him to coordinate the various activities within his project.
2. Provide the Chief Engineer with up-to-date information concerning the projected utilization of engineering manpower.
3. Provide other departments such as Drafting, upon whose services engineering depends, with up-to-date forecasts of workload requirements.
4. Provide a basis for estimating the engineering budget.

The Scheduling System consists of:

1. A graphical schedule for each project.
2. A program for updating the schedules.
3. A series of computer-generated reports which indicate the latest revision of the project manpower requirements.

The schedule format is similar to that used by the EXPERT system.<sup>1</sup> The engineer is asked to layout on a calendar scale all activities associated with the project, including such non-engineering activities as the preparation of programs and publications. Figure 1 illustrates a hypothetical project schedule.<sup>2</sup> Experience has shown that graphically laying out a project at an early stage aids the engineer in coordinating the various phases of the project and in meeting delivery date requirements. Potential bottlenecks, such as those caused by the failure to order long-lead components at an early enough date, can often be foreseen and thus avoided by scheduling in advance.

Shown on the schedule are estimates of the manpower required for each phase of the

## LINC (Continued)

A program written by Dr. Killam at Stanford University was also demonstrated. This particular program allows you to take any particular wave form or data and display it immediately on the oscilloscope, and, by hitting individual keys on the keyboard, perform various functions, i.e. differentiation, integration, reverse polarity, smoothing, enlarge amplitude, decrease amplitude, or plot a bargraph. A number of other wave forms were displayed in this form such as fetal electrocardiograms. The ability to manipulate and be able to process data in this manner was of extreme interest to many individuals. Then, a demonstration and discussion of the work that Washington University was doing on the separation of the fetal heartbeat from the combination of the maternal and fetal electrocardiogram followed. Using a memory scope, certain characteristics of both the fetal and the maternal heartbeat were displayed such as breathing effects, etc. By doing this, one is able to average out the maternal EKG completely so that only the fetal EKG remained.

The last demonstration that was performed was to take an individual and connect him to an electrocardiogram unit. The output from this unit is connected directly into an A to D channel of the analog input of the LINC, thus performing on-line processing of electrocardiograms. In this manner, by hitting the numbered keys on the keyboard, a number of averaged EKG's appeared on the scope. Five letters then appeared around this EKG and these were: "R" for indicating the R wave of a typical electrocardiogram, the "P," "Q," "S," portions of the electrocardiogram. Of interest was the difference between a single EKG with all the noise and an average of 16 with all the noise averaged out. Again, one could take this average EKG and store it away on the tape, call for a program such as the Fourier Analysis and do a frequency analysis of the EKG that had just been obtained on-line.

Following the completion of the demonstrations, it was pointed out that a number of input-output units, such as IBM Compatible tape, calcomp plotters, teletypewriters and X-Y plotters have been interfaced to date with the LINC performing a variety of applications.

For further information concerning LINC and its availability, please contact Mr. Morton Ruderman at DEC, Maynard.

DECUSCOPE is published monthly for Digital Equipment Computer Users Society. Material for publication may be sent to: Editor, DECUS, Maynard, Massachusetts.  
Circulation: 1,000 copies per month

project; included in these estimates are the engineering, technician, drafting, production, and publications requirements. From the estimates, manpower loading forecasts, which are updated periodically, are derived.

These summarized estimates provide the Chief Engineer with information regarding the availability of his technical manpower for work on future projects. The service areas are provided with advance notice of the work load requirements for each project and of the approximate dates that the work will be expected.

Experience has indicated that a given service department can effectively schedule its work if it receives advanced notice of that work's arrival in the department; the Scheduling System provides this information.

The project schedules also provide a quantitative basis for estimating the labor portion of the engineering budget. By applying standard costs to the manpower estimates indicated on the schedule, realistic budget estimates may be obtained. This technique, as well as aiding managerial planning, tends to give the project engineer a greater appreciation for the costs involved in new product development.

The information required for updating a schedule is the present date and the status of each current activity (as shown by the markers on Figure 1). This information serves as the input data for a FORTRAN Scheduling Updating Program which operates on a PDP-4 Computer with an 8K memory.

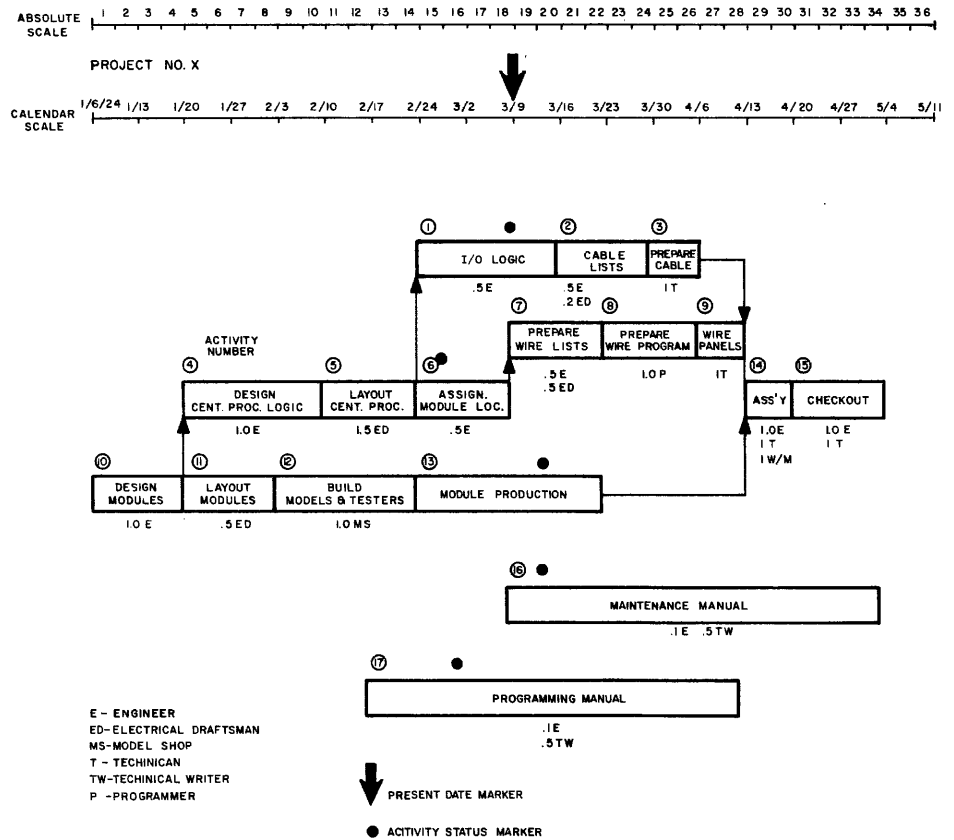

Figure 1

The program acts upon the current status information and, in effect, slides the project activities forward or backward through time, arriving at revised estimates of the starting and completion dates of each activity. In addition, the program retotal the manpower requirements and prints a revised manpower load report for each service area.

The system has been designed with the engineer's aversion to "red tape" in mind. Having originally prepared the schedule, not an ominous task, the engineer need

only indicate periodically the current status of the project. Up-to-date reports are issued without having to re-do the entire schedule.

The output of the system is a series of reports for each department giving the latest revision of the manpower requirements, summarized both on a weekly and a project basis. The engineer receives a report giving projected completion dates, according to his latest progress report.

The system is presently being implemented at DEC; the programs and additional information will be available soon.

<sup>1</sup>As described in "The EXPERT Approach to Program Control" by Irving C. Zacher, Military Systems Design, Volume 7, No. 5, October, 1963, pp. 26-29.

<sup>2</sup>The arrows indicate that a given activity may not be started until certain other activities are complete.

## 340 INCREMENTAL DISPLAY APPLICATIONS

### Psychological Studies

The Decision Sciences Laboratory of the Electronic Systems Division, Hanscom Air Force Base, will use four 340 Displays with the PDP-1 in a series of experiments aimed at evaluating and improving human performance in sequential information gathering. Many of the experiments will depend on visual stimulation and response. With the display, stimuli can be shown on the scope face and the subject can respond directly to the display with the light pen "writing" his answers on the scope by selecting among displayed multiple choices.

In addition to the four incremental displays, the laboratory will include a large projection screen and random access slide projectors under program control. Movable walls will isolate the individual stations in other experiments to permit running several subjects simultaneously and without interaction.

Harvard University will also be using the 340 Display with the PDP-4 for psychological studies.

### Computer-Aided Design

The general-purpose experimental display system for the U.S. Army Signal Corps is based on the PDP-4 and the 340 Display. The new system can display and modify information generated by a second computer or it can function independently. The information appears on a 17-inch cathode ray tube enabling the operator to respond by using several types of console controls. Information stored in the memory of the PDP-4 is presented on the 340 as dots, lines, curves, characters, or shapes. The operator can generate new information or modify that already in memory with push buttons, knobs, a typewriter keyboard, and a rotating ball added to the display console.

The new controls can execute a variety of functions, depending on the roles assigned to them by the operating program being used in the computers. The rotating ball, recessing in the console, can turn indefinitely in any direction, greatly extending the movement capabilities of joysticks and other lever-like devices used earlier with displays. The keyboard permits the operator to feed in text without returning to the

## THE 340 INCREMENTAL DISPLAY

The DEC Type 340 Precision Incremental Display is a powerful new incremental cathode ray tube display that operates asynchronously with the driving computer program. The Type 340 Display uses the computer memory to hold the display data and control words but "steals" these words when required without interrupting the program in execution. The 340 Display can be driven by the PDP-1, PDP-4, PDP-6 or PDP-7 computers.

The 340 will display information at any one of 1024 x 1024 addressable points in a 9-3/8" square in one of several modes: Point, Increment, Vector, or Vector Continue. Operation in Point Mode is simply the display of a point at the specified coordinates on the screen. Operation in Increment Mode is the display of four points per 18-bit word. Each point is one increment in any combination of orthogonal directions away from the last point. In Incremental Mode, up to 15,000 points can be displayed in one frame, flicker free. Vector Mode generates a vector by incrementing the beam from point to point along the hypotenuse of the triangle defined by the specified  $\Delta X$  and  $\Delta Y$ . Vector Continue Mode simply permits the repeated display of a specified vector until the edge of the screen is violated. The scale of the increments is variable from 1, 2, 4, or 8 points per increment.

Several options are available to enhance the utility of the 340 Display: 370 Light Pen, 347 Sub-Routine Option, 342 Character Generator, and the 343 Slave Display option.

370 Light Pen - The 370 Light Pen is a high-speed photo sensitive device that permits the display operator to establish a reference in the computer program to a specific displayed point on the screen.

347 Sub-Routine Option - The 347 Sub-Routine Option permits the display to jump in and out of sub-routines within its specified data table. Thus, repeated patterns need be stored only once in the data table and can be displayed via a sub-routine at different locations on the screen.

342 Character Generator Option - The 342 Character Generator generates the display of one of 64 alphanumeric characters from each unique combination of a 6-bit code. This vastly reduces display storage and memory access time requirements.

343 Slave Display Option - The 343 Slave Option permits up to 16 slave displays to be driven by the Master 340. Each slave has independent intensity and light pen control.

## REMINDER TO ALL DECTAPE USERS

From: Don Vonada, DEC

### DEctape Program Timing

The nominal tolerance between flags when tape is moving in the forward direction (direction in which the timing and mark information is written) is  $\pm 10\%$ . However, when tape moves in reverse the timing varies as much as  $\pm 30\%$ .

The reason is the drive motors run at a constant speed. Thus, as tape winds on to the reel, the effective diameter of the reel changes, which in turn effects the tape velocity.

The timing information is placed on tape at discrete intervals of time; therefore, when writing the timing information, the physical separation between timing marks increase as tape is moved from one end to the other. The 10% tolerance accounts for motor speed variations. When the tape is used in a direction opposite to the direction in which the timing information was written, the highest tape speed occurs where the timing marks are more closely spaced. This, in conjunction with the motor speed variation, accounts for the 30% tolerance. For example, if a flag is expected to occur every 200  $\mu\text{sec}$ , under worse case conditions, the flag could occur in 140  $\mu\text{sec}$ .

## MODULES AND EXPERIMENTS

Helping farmers market better quality asparagus at a lower cost is the goal of an experimental harvester development program being conducted by the Agricultural Engineering Department at Rutgers, The State University, in New Brunswick, N. J.

The harvester is pulled behind a tractor, automatically selecting and cutting the stalks that are ready and leaving less mature ones for another day. Digital's System Modules solved the problem of cutter head positioning posed by variations in the speed of the tractor.

FLIP CHIP Modules are being used in place of electromechanical logic devices to program behavioral research experiments at the university. The FLIP CHIPS and their accessories are being used by Dr. David Lester (Center of Alcohol Studies) to build special circuits for operant conditioning experiments in which subjects are rewarded for properly responding to various stimuli.

Earlier test apparatus used stepping switches, relays, and similar electromagnetic, electromechanical logic devices. Advantages in replacing this equipment with solid-state modules are more flexibility and reliability and the elimination of relay chatter and other noise which often affected the subject as well as the experimenter.

PDP-4 console typewriter. Changes to the Type 340 logic extend its subrouting capability, permitting a subroutine hierarchy to define pictures in much the same way that the subroutine hierarchy of a programming system would function on a general-purpose computer. The system includes the PDP-4, perforated tape reader, high-speed data multiplexer, address and save registers for the display, control and status circuits for the interface with a second computer and Digital's High Speed Light Pen.

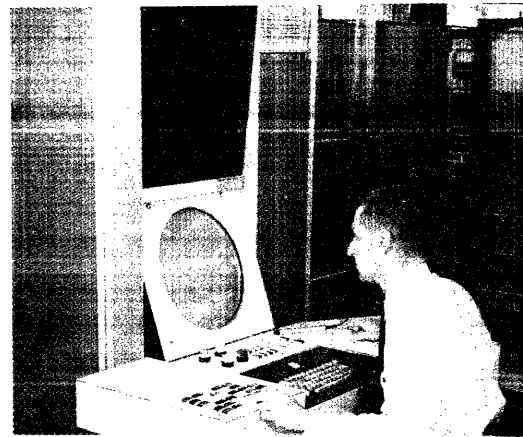

The 340 Display for the Signal Corps

The PDP-5 computer and 340 Incremental Display at the Signal and Information Processing Research Department of the Bell Telephone Laboratories at Murray Hill, New Jersey will form the heart of a new interaction system which will be used both to enter and to receive graphical data in the Laboratories' Computing Center. This interaction system will have access to the main computational facilities between normal problem runs.

A core buffer will be used to store output information for display on the scope and to receive new input information so that the display system functions independently between interactions. The PDP-5 computer monitors the display operation and also controls a Type 370 High Speed Light Pen for use in entering or modifying data. The purpose of the system is to allow quick looks at graphs, diagrams, and other information and to facilitate the rapid interchange of information between problems.

Other elements of the system are Digital's Type 137 Analog-to-Digital Converter and Type 451A Card Reader and Control.

### General Purpose I/O Device

The University of Western Australia will be using the 340 Display with the PDP-6 at their computation center to control and collect data from laboratory equipment connected directly on line at the same time the computer is performing its normal computing service. Working from individual teletype sets connected from remote sites to the PDP-6, several persons will be able to use the machine at the same time for calculations. The display and light pen will provide a fast man-machine communication channel which will be used on a variety of research projects at the university, including work in molecular structure, psychology, and mathematics.

The 340 Scope Display is being used with the PDP-1 at United Aircraft Corporation's Research Laboratories, New Haven, Connecticut. The display has been somewhat modified to better suit UAC's needs. A 2,000 word, 18-bit buffer memory is used to store the display data and to maintain the scope display. Data in this memory can be modified while a display is in progress. A new scope mode (jump mode) allows the display address counter to be set or changed.

The light pen system and the ability to read the scope X or Y coordinates (10 bits)

# THE SDC TIME-SHARING SYSTEM

part two: service routines & applications

Reprinted with permission from  
Datamation  
December, 1964

by JULES I. SCHWARTZ

With the commands and functions discussed so far, a user can load, run, and debug programs, as well as have other miscellaneous services performed. It is, of course, necessary that numerous other services also be provided. The functions described so far were performed entirely by the executive system. The object programs were considered to be just code running in response to basic commands. However, the techniques for providing additional services are actually accomplished through the use of object programs. Object programs can be written to provide other necessary services; such programs are called service routines. Since service routines are object programs—and there is no limit to the number or kind of object programs that can be used—there is in effect no limit to the number of services that can be provided.

*Service Routines for Producing Object Programs.* In some respects, the most common technique for producing object programs is similar to that used in standard computing installations. The program is written in a symbolic language, stored on a magnetic tape (or disc), and then compiled. The output of the compilation is a binary program—in this case compatible with the executive LOAD command—and a listing. When the symbolic programs require modification, the necessary changes, deletions, and insertions are made by using the tape (or disc file) that contains the program, and a new tape (or disc file) is prepared.

## *File Maintenance*

The preparation and maintenance of symbolic tapes and disc files is done with the service routine called FILE. The functions of the routine FILE are:

- *Generate Symbolic Files.* Symbolic files may be stored on tape or disc from teletype inputs or through the card-reader.
- *Update Symbolic Tape Files.* Symbolic files may be updated on-line without destroying the original file. Using the update feature, lines may be inserted, deleted, or replaced via the teletype.
- *Merge Symbolic Tape Files.* An additional feature of the tape update portion of FILE allows files from a second tape to be merged with files of a first, base tape. The file to be merged may be inserted at any point within a file on the first tape.
- *Print Symbolic Tape Files.* Symbolic files or parts thereof may be listed either on the user's teletype or on an output tape for later printing off-line. This feature may also be used to make extracts or duplicates of symbolic tapes.
- *Survey Symbolic Tapes.* To review the contents of a symbolic tape that contains a number of files, the user may wish to survey the tape. A request for this operation will cause FILE to search the tape and to print the first "n" lines of each file on the user's teletype.

## *Compilers*

There are several compilers available in this system. The

JTS compiler was designed to provide JOVIAL and SCAMP (machine language) compilations under the time-sharing system. JTS accommodates a subset of the JOVIAL J-2 and J-3 languages as well as a subset of SCAMP. The compiling function of JTS can be performed on-line, in a sense, if the user wishes to wait at his teletype and review any coding errors that JTS outputs on the teletype. In addition, the user can operate his object program immediately after successful compilation. The binary object program produced by JTS is on a tape that conforms to the format requirements for system loading. The user can specify the type of program listing to be output on his listing tape.

A second compiler available to users is called SCMP. It has the same operating characteristics as JTS; however, the language it compiles is the complete SCAMP.

Other compilers, including SLIP and LISP, are either available or are being implemented.

## *IPL-TS*

A somewhat different scheme is provided by the service routine IPL-TS. In this case, the object program (coded in IPL-V), prepared through use of FILE, is assembled by this service routine. The assembled program is then made part of the IPL-TS system, which can be saved (on option) and later reloaded with the LOAD command. When it has been loaded, the program may be executed interpretively by the IPL-TS service routine. This routine also provides a great number of on-line checkout aids to the user during execution of his program.

The service routines and techniques discussed so far permit users to produce and modify both small and large programs in a manner analogous to other kinds of computer systems although they are generally controlled on-line. Techniques more appropriate to time-sharing systems are also available for producing, checking out, and running programs. These techniques provide the capability for coding and executing programs on-line (at the teletype) without going through the various independent steps necessary in the file and compile process. The service routines now available for this purpose are called TINT and LIPL.

With TINT, one may program in the JOVIAL language; LIPL provides the ability to program in the IPL-V language. In both routines, execution is done interpretively, providing many on-line debugging and communication aids that are not available when executing a binary program in the normal fashion. The general description of these programs is as follows:

TINT was developed to provide a vehicle for on-line coding and execution of JOVIAL programs. The applications of the on-line interpreter are:

- Program composition
- Debugging and editing
- Rapid formulation and computation

## *Functions*

- To accept, perform legality (grammar) checks on,

## SDC TIME-SHARING . . .

and interpret statements to a given subset of the JOVIAL language.

- To permit execution of all or part of small JOVIAL programs.
- To permit dynamic input of variables to a JOVIAL program that is to be executed.
- To permit dynamic output of results obtained through execution of a program.
- To permit on-line symbolic corrections to be made to existing code.
- To permit storage of symbolic code composed with TINT and then transferred to tape so that it may later be compiled or re-executed interpretively.

Fig. 10 shows an example of a small TINT program as coded and executed on-line.

The IPL-TS interpreter described earlier also permits the programming and execution of on-line coded pro-

Fig. 10. Example of a TINT Program

```

$ 1 "THE EUCLIDEAN ALGORITHM"
$ 2 "GIVEN TWO POSITIVE INTEGERS A AND B"
$ 3 "FIND THE GREATEST COMMON DIVISOR"
$ 4 S1. READ A,B;
$ 5 X = A; Y = B;
$ 6 S2. IF X EQ Y;
$ 7 BEGIN PRINT 30H(THE GREATEST COMMON
    DIVISOR OF),
$ 8 A,3H(AND),B,2H(IS),X;
$ 9 GOTO S1; END
$ 10 IF X LS Y;
$ 11 BEGIN Y = Y-X; GOTO S2; END
$ 12     X = X-Y; GOTO S2;
$PRINT COMPLETE
$ENTER COMMAND
?EX
    A = ? 1024
    B = ? 512
THE GREATEST COMMON DIVISOR OF 1024 AND
512 IS 512
    A = ? 234
    B = ? 86
THE GREATEST COMMON DIVISOR OF 234 AND
86 IS 2
    A = ? 234
    B = ? 84
THE GREATEST COMMON DIVISOR OF 234 AND
84 IS 6
    A = ? 234
    B = ? 82
THE GREATEST COMMON DIVISOR OF 234 AND
82 IS 2
    A = ? 234
    B = ? 80
THE GREATEST COMMON DIVISOR OF 234 AND
80 IS 2
    A = ? 234
    B = ? 78
THE GREATEST COMMON DIVISOR OF 234 AND
78 IS 78
    
```

grams. In this case, the technique is analogous to that used in programming off-line (using tape input) except that the code is assembled from teletype input. Also, with this routine, programs prepared with the FILE program and assembled from tape can be modified by program input on a teletype. A brief example of a LIPL program is given in Fig. 11.

A number of other routines exist and are being written for use in the SDC time-sharing system. These include

routines whose functions range from information retrieval to tape copying.

## applications

Thus far this article has described the characteristics and capabilities of the time-sharing system in use in the Command Research Laboratory. The system has been in

Fig. 11. Example of a LIPL Program

## LIPL-READY

```

RT S0 = (A0 10M0 109-3 J100) 9-3 = (40H0 J75 J71,J151)
AO = (11M0 J50 10M0 J68 10P0 709-5,9-1 J60 709-6 12H0 61M0
51M0,9-2 J60 709-3 12H0 52H0 12M0 J2 709-2 30H0,9-1)
9-3 = (30H0 A0 70 (108.0 21M0,9-13,9-4)
9-4 = (40M0 51W0 20M0,J30) 9-5 = (J4,9-4) 9-6 = (108.0 21M0,9-4)
DTPO = (0 $RED$ $WHITE$ $BLUE$ $GREEN$) MO = (0 C1 C2 C3 C4 C5 C6)
C4 = (0 C1 C3 C5 C6) C5 = (0
C1 C4 C6)
C6 = (0 C1 C2 C3 C4 C5) NL GT S0
    
```

C1	0232254	21	RED
C2	0236814	21	WHITE
C3	0236869	21	BLUE
C4	0236814	21	WHITE
C5	0236869	21	BLUE
C6	0236848	21	GREEN

An IPL-V "map-coloring" program, written and executed on-line under time-sharing in Linear IPL (LIPL).<sup>\*</sup> This program determines the colors of all countries (symbols C1 to C6) on a map (list MO) such that no adjacent countries are colored alike.

The six-country map for this example is configured as follows:

C1 C2 C3 C4 C5 C6

<sup>\*</sup>LIPL was written by Robert Dupchak of the RAND Corporation.

operation since June 1963, after an initial development of approximately five months. Currently it is operating eight hours a day and is virtually the only means for using the computer during the day in the Command Research Laboratory.

Of some interest are the numerous and diverse applications of the system. These serve to show the possibilities offered by the present and relatively young system as well as to point out the large range of applications and services that a powerful concept such as time-sharing can provide. A list of some of the current applications in the Command Research Laboratory follows:

- Natural Language Processors—used for parsing English sentences, answering questions, and interpreting sentence-structured commands.
- Group Interaction Studies—in which teams of players are matched against each other, and in which the computer is used to measure individual and team performance.
- General Display Programming—in which the programs are used as vehicles for generating and modifying visual displays according to the user's keyboard inputs.
- Simulated Command Post—a realistic simulation of a command post has been produced, and such problems as the display requirements for this organization are studied within this framework.
- Hospital Control—the data for a ward of hospital patients is maintained and retrieved through the system, with access from stations in the hospital.
- Text-Manipulation—a sophisticated text-manipulation program has been developed.
- Police Department Crime Analysis—using some of the techniques found in the studies of natural-language

comprehension, reports of crimes are compared with a complete history of criminal reports to establish patterns and isolate suspects.

- Personnel File Maintenance—personnel records of SDC are maintained and accessed during the time-sharing period.

### comments and prospects

The results of the first year's use of the SDC time-sharing system have been encouraging. A considerable amount of work has been accomplished using it, a great deal has been learned about the problems of time-sharing, and a number of applications have had a great deal of exercise which could not have been attempted with more traditional computing center techniques.

The actual development of the system has been in roughly four stages, the first three of which lasted about six months each. These stages are:

- Design and Checkout of the Initial System—During this period the emphasis was on the executive system, with only a slight effort in designing service routines.
- Initial Use of the System—The main concern during this period was making the system "stay alive." (It frequently didn't, causing numerous frustrations and feelings of ill will toward time-sharing). The majority of users during this period were members of the Time-Sharing Project who were writing and checking out service routines. A few of the applications systems were begun during this period. The number of services and conveniences for the user were minimal. The system was in operation between two and four hours a day.
- Full-Scale Use of the System—During this period, the time-sharing period operated eight hours a day. A large number of applications were programmed, checked out, and used. The set of service routines was expanded, and the ones that existed were sharpened considerably. A number of the "little annoyances" of the system were eliminated, and in general the system was made much more reliable and easier to use. During these three periods, a large number of changes to the equipment was made. Probably a significant change was made on the average of once every six weeks. This, of course, did not aid the reliability of software or hardware.
- The Future—We are currently in the fourth phase of this system. Changes to hardware should be relatively few now, so that the software emphasis can be on improvements; there are seemingly an infinite number of improvements possible. They range from such ideas as telling the user his program's status and the time of day when he asks for them to improved executive input-output buffering schemes and techniques which permit a user instantaneous access to a network of programs on other computers as well as the Q-32. (There is currently a list of over 50 such items waiting for implementation).

The fact that so much remains to be done might lead one to the conclusion that the concept has not been very satisfactory. On the contrary, we can probably say that our experience so far with time-sharing has proven quite satisfactory, and the true potentials of such a system are now becoming clear and realizable.

When "discussions" of time-sharing (and on-line computer usage) are conducted, there is generally agreement on the use of the concept for a number of applications, but there is considerable debate concerning the "economics" of it—whether more traditional computer systems make more efficient use of the computer. Like many such questions, the answers cannot be found easily. Time-sharing

permits many runs on a computer and instantaneous response to all users. It also encourages techniques which are quite valuable but not practical otherwise (e.g., solutions by trial and error, use of displays, on-line debugging, single-shot retrieval of information, etc.). In some respects, it makes excellent use of a computer. For example, since there is almost always "something" going on, time to mount and demount tapes is never wasted time.

On the other hand, it can be pointed out that in the "worst case" of time-sharing today—where big programs must be swapped frequently—the efficiency of time-sharing is low. (This applies primarily to efficiency of throughput, not response time, which is another measure of time-sharing efficiency). For certain kinds of programs—those which require long periods of compute time and where human interaction cannot help the process—time-sharing is of no direct value.\* Time-sharing and on-line computer use tends to discourage or make difficult retrieval of large quantities of printed output. Although time-sharing assists man-machine interaction by letting users use the computer on-line, it also frequently requires humans to be present at jobs they would be quite happy to let run without them.

In the system at SDC, certain of these arguments are recognized. However, at the present time, they do not represent serious difficulties. The throughput and response time for the system are quite adequate for a reasonably heavy load. If the capacity of the system were to be increased (primarily by increasing the size of the drums), there seems little question that, without considerable improvements in the system, the economic factors would be more serious. Thus, although we have been able to tolerate a close to "worst case" scheduling mechanism in the early phases, areas of unoverlapped swap and input-output will have to be eliminated with a larger average load. Also, the running of programs in a "background" fashion, so that humans aren't required and long computations don't unnecessarily degrade the system, is an item of high priority in the future.

In conclusion, one can view the present system and the experience so far and have a great feeling of optimism for the future. Emphasis from now on will be in areas that will stress significant improvement in the techniques and tools available to the user. The problems of hardware modification, hardware and software reliability, and others due to lack of experience or haste in production are diminishing. Even with these various areas of growing pains, a surprising amount has been accomplished.

Time-sharing seems to hold a key to much that has been bothering the computer using community. The computer can be brought close to the user. Problems not heretofore solvable can be pursued. The problems of economy in some areas are better now with time-sharing, and in others no impossible problems seem to exist. Large-scale use of computers on-line seems to be with us to stay.

### BIBLIOGRAPHY

This Bibliography contains additional information about the System Development Corporation Time-Sharing System.

1. Rosenberg, A. M. (ed.) *Command Research Laboratory User's Guide*. SDC TM-1354 Series, November 1963.
2. Schwartz, J. I., E. G. Coffman, Jr., and C. Weissman. *A General-Purpose Time-Sharing System*. SDC SP-1499, 29 April 1964.
3. Schwartz, J. I., E. G. Coffman, Jr., and C. Weissman. *Potentials of a Large-Scale Time-Sharing System*. To be published in the Proceedings of the Second Congress of Information System Sciences, November 1964. (Also available as SDC SP-1723.)

\*There is the possibility that the compute time can be cheaper when shared than when alone.

are available. A simple pointer circuit has been added to aid in light pen selection of one of several curves on the scope. On a light pen stop, the pointer can be read to directly identify the curve.

The character mode appears to the programmer exactly as character generator option. The data for each character is, however, stored in this buffer memory. Each character can be any table of scope data. The exception being that the first escape bit signals the end of character. A dispatch table is also stored in this memory to route concise code to its proper data. Both character data and dispatch table can be loaded by each user to make a very flexible character generator.

The display is largely used as another input/output device for a real-time flight simulator, as output curves and numerical data are displayed. This can be mixed with a TV display for pilot viewing. Curves which are used as data for the simulation can be modified with the light pen. The PDP-1 and Type 340 scope display make a very flexible simulation tool.

### ACCELERATED RADIX DEFLATION ON THE PDP-7 AND PDP-8

By: Donald V. Weaver, Consultant, New York City, New York

These are typical programs by the improved method of accelerated radix deflation. An explanation of the mathematical basis is to be provided in the writeup of this note:

#### Program For 6-Bit Code on PDP-7

```

dbin, 0      /ABC in 6-bit code
  dac T / (64A+B)64+C
  and A
  cll rtr
  rar / 8
  dac T3
  rtr / 2
  add T3 /10
  add T / (74A+B)64+C
  and AB
  dac T2 /64
  cll rtr
  rar / 8
  dac T3
  rtr / 2
  add T3 /10
  cma
  add T2 /54
  cma /-54(74A+B)
  add T /100A+10B+C
  jmp i dbin

```

```

T, 0
T2, 0
T3, 0
A, 770000
AB, 777700

```

/Figure is 26 words, 56 microsecs.

#### Program for 4-Bit Code on PDP-8

```

DBIN, 0      /ABC in BCD code
  DCA T
  TAD T / (16A+B)16+C
  AND A
  CLL RAR
  DCA T2 / 8
  TAD T2
  RTR / 2
  TAD T2 /10
  TAD T
  AND AB / (26A+B)16
  DCA T2 /16
  TAD T2
  CLL RAR / 8
  TAD T2 /24
  RTR / 6
  CIA /-6
  TAD T
  JMP I DBIN /binary value
                                     in AC

```

```

T, 0
T2, 0
A, 7400
AB, 7760

```

/Figure is 23 words, 50-microsecs.

## NEWS ITEMS

### University of Bonn

University of Bonn, Bonn, Germany has ordered a PDP-6 to be used in the control of a Precision Encoding and Pattern Recognition (PEPR) System.

This system will include the PDP-6, 2 core memories, 16,384 words ea., Data Channel Type 136, MagTape Control Type 506-521, DECTape Transport 555, DECTape Control Unit 551, Type 340 Display w/light pen, Mag Tape Transport, Card Reader and Control, Line Printer and Control, 630 Data Communication System for three stations utilizing console typewriter and two additional teleprinters Type KSR 33.

### University of Michigan

The University of Michigan's Space Physics and High Altitude Laboratories have ordered a Telemetry Data Conditioning System from Digital Equipment Corporation for use in data format conversion.

The system will preprocess analog data recorded during rocket and balloon flights. The laboratories are carrying out the work under the sponsorship of the National Aeronautics and Space Administration's Goddard Space Flight Center. In operation the system will sample, at intervals selected by the operators, data from 10 analog channels and one time code translator channel, convert the samples into binary digital values, group them in a buffering memory area, and then write them on a second magnetic tape transport.

The system is built around Digital's new PDP-8 computer, a general-purpose machine with integrated circuits, a 1.6-microsecond memory cycle time, and multiple auto-indexing registers.

### Professional Data Services

Professional Data Services of Ann Arbor, Michigan has purchased a PDP-5 for use in several commercial data processing assignments.

Some of the first applications will be drug store inventory control, plumbing contractor parts analysis, accounting, and an engineering service utilizing FORTRAN programming. The PDP-5 at Professional Data Services will include a 4096 memory and the console tape teleprinter.

### Fort Devens To Use Digital Logic Kits

Thirty-one Logic Kits to train maintenance personnel in electronic computer techniques have been delivered by Digital Equipment Corporation to the United States Army at Fort Devens in Ayer, Massachusetts.

The kits enable instructors and students to

rief comment on the mathematical model may help in interpreting the code although the algebra proves itself.

It is based on the factoring formula,

$$X^2 - Y^2 = (X + Y)(X - Y)$$

and might be called a Fermat-like method.



perform classroom demonstrations and laboratory experiments with such computer elements as up and down counters, shift registers, decoders, and arithmetic registers. They are built around solid-state circuit modules which can operate at frequencies up to 500 kilocycles. The modules are packaged in plug-in aluminum cases for mounting in panels supplied with the kits. Stacking patch cords, power cords, and power supplies are also included.

At Fort Devens, each kit will contain an inverter, a diode NOR, four flip-flops, a delay, a clock, pulse generator, power supply, mounting panel, and cords.

#### Eight In/Out Stations Added to Time-

##### Sharing SDC Net

System Development Corporation of Santa Monica, California has ordered additional communication subsystem equipment from Digital for use in expanding its time-sharing computer system.

The new equipment will be used to enlarge the Type 630 Data Communication Subsystem, permitting the addition of eight remote or local on-line Teletypes or typewriters, making a total of 43 channels.

Major elements of the system are an AN/FSQ-32 computer serving as the central processor, Digital's PDP-1 computer controlling real-time inputs and outputs for the central processor, drums providing a half-million words of program storage capacity, a disc providing an additional four million word capacity, and 16 magnetic tape transports.

In addition to 35 user keyboard-printers, the input/output subsystem includes six cathode ray tube displays and data handling equipment for use by eight subscribers at distant locations.

One such location was in Copenhagen, Denmark, during the World Health Organization's recent conference on information processing and medicine. In what is believed to have been the longest span between a computer and an on-line user, physicians attending the meeting saw several demonstration programs intended to dramatize the capabilities a time-sharing computer can provide in an on-line medical data processing system.

More than 100 persons now use the SDC system, many of whom are from some 12 organizations outside of SDC. It has been operating on one shift since January 1964.

The goal of the project, sponsored by the Advanced Research Projects Agency of the Defense Department, is to study methods of employing "public utility"-like systems to maximize the help computers provide scientists and engineers and to minimize the cost of using them.

#### "SUPERDECIMAL" DATA BYTES ON THE PDP-7

By: Donald V. Weaver, Consultant, New York City, New York

Three-place decimal numbers, represented in the accumulator of PDP-7 by a set of three, 6-bit digit-codes, can be converted into true binary numbers readily by programs built on the multiply-ten model, "xor" to unpack, and scale right.

A minimum-space edition of such a program could be  
dbin: 0, dac T, and BC, jms sbr, dac T, and C, jms sbr, jmp i dbin,  
using masks C=77, BC=7777 and calling a subroutine "sbr" to unpack, scale right, and sum on successive digits in the polyval tradition,  
sbr: 0, dac T2, xor T, cll rtr, rar, dac T, rtr, add T, add T2, jmp i sbr,  
so that the space/time figure for the program is 22 words/77 microseconds. Faster time is obtained by straight-line coding in 26 memory registers, execution time 63 microseconds.

This program is completely modular. It serves as a callable function implementing the reception of multi-word-length input data, floating point and the like, and particularly on binary tape.

The input code may be IBM or ASC-II code, for example. Because ASC-II code "looks binary" to the high-speed reader it sluffs channels 7 and 8 and will assemble a data tape prepared in proper format into three-digit words of "excess 60" character codes (octal 60 to 71) representing the decimal digits 0 to 9. Zone bits may be tested before erasing, and acceptable data words are delivered to the conversion program.

The conversion program in turn delivers successive outputs to the main program in a BINARY-CODED SUPERDECIMAL mode, and the main program may now direct the Processor to proceed in a simple way to transform these high-radix data, serially if desired into a single, full binary value.

Modularity works in both directions. The basic conversion program with new masks and "c ll rtr" deleted in the subroutine, is turned into a program that processes decimal numbers packed in condensed 4-bit BCD code. The PDP-7 accumulator can take longer bytes of the condensed code, and the new program may be adapted to this broader coverage by an initial insert of three instructions, "dac T, and ABC, jms sbr" with unpack masks ABC=7777, BC=377, C=17 to process four-digit BCD-coded numbers. A space/time figure for the four-digit program is 24 words/110 microseconds.

Conversion programs built on the standard multiply-ten model, are evidently quite adaptable, and while somewhat longer they are older and more familiar to programmers than the newer method of ACCELERATED RADIX DEFLATION.

Some coded programs on the radix deflation method are therefore given in the reference. As a typical example, using accelerated radix deflation (in contrast to normal radix deflation, DECUS No. 5/8-7, December 1964 DECUSCOPE, p. 5) one can generate a program for the PDP-7 with a space/time figure of only 21 words/46 microseconds to convert three-digit numbers in condensed 4-bit BCD code; and an accelerated program to convert 6-bit code has a figure of 26 words/56 microseconds.

The method of accelerated radix deflation operates straight-line within a basic unit of three digits. It may be extended to four digits by normal radix deflation, or it may be iterated on the odd integers to cover five, seven or more digits if register action makes such bytes feasible.

Some of the differences in implementing the method on PDP-7 and PDP-8 are indicated in the reference. It will be noted that three-digit conversion on the PDP-8 is under 50 microseconds and other figures are substantially improved over those given in December DECUSCOPE.

NOTE: The names SUPERDECIMAL and BINARY-CODED SUPERDECIMAL and their commercial application to data processing are the property of the author.

## INFORMATION DISPLAY SYMPOSIUM

The Society for Information Display will hold its Fifth National Symposium on Information Display at the Hotel Miramar, Santa Monica, California on February 25 and 26, 1965. Subjects for papers are:

Displays in Space  
Displays in the Post -1970 Era  
Displays in Simulation  
Business, Industrial and Educational Displays

Papers Chairman: R.L. Kuehn, 1831 Seadrift Drive, Corona del Mar, California

### PDP-7 and PDP-4 PROGRAM COMPATIBLE

With FORTRAN II (8K) working as the first PDP-7 was delivered in December, many of the programming problems of a new computer were already past. The PDP-7 library now includes a number of the most useful arithmetic and input/output routines as well as a full set of diagnostic and maintenance programs. Also part of the PDP-7 library is the Assembler, Editor (on PDP-4 called Canute), and the DDT (Digital Debugging Tape) which permits rapid computer-aided program checking. FORTRAN II will soon be ready for PDP-7 users on DECTape (Digital's microtape system), thereby making a load-and-go FORTRAN possible. DECTape reads and writes the redundantly recorded magnetic tape at speeds of 15,000 characters per second. Units as small as a single word are individually addressed without disturbing adjacent data.

The incorporation of FLIP CHIP all-silicon modules in the PDP-7 does not affect its program compatibility with the 4. With a memory cycle time of 1.75  $\mu$ sec, the PDP-7 uses 10 megacycle circuits to perform an addition in 3.5  $\mu$ sec, average multiplication in 6.1  $\mu$ sec, and average division in 9  $\mu$ sec. It uses 18-bit words and directly address 8192 of a possible 32,768 core memory locations.

Applications of the PDP-7 include an automated computer controlled measurement system, nuclear research analysis, systems science laboratory, and process control.

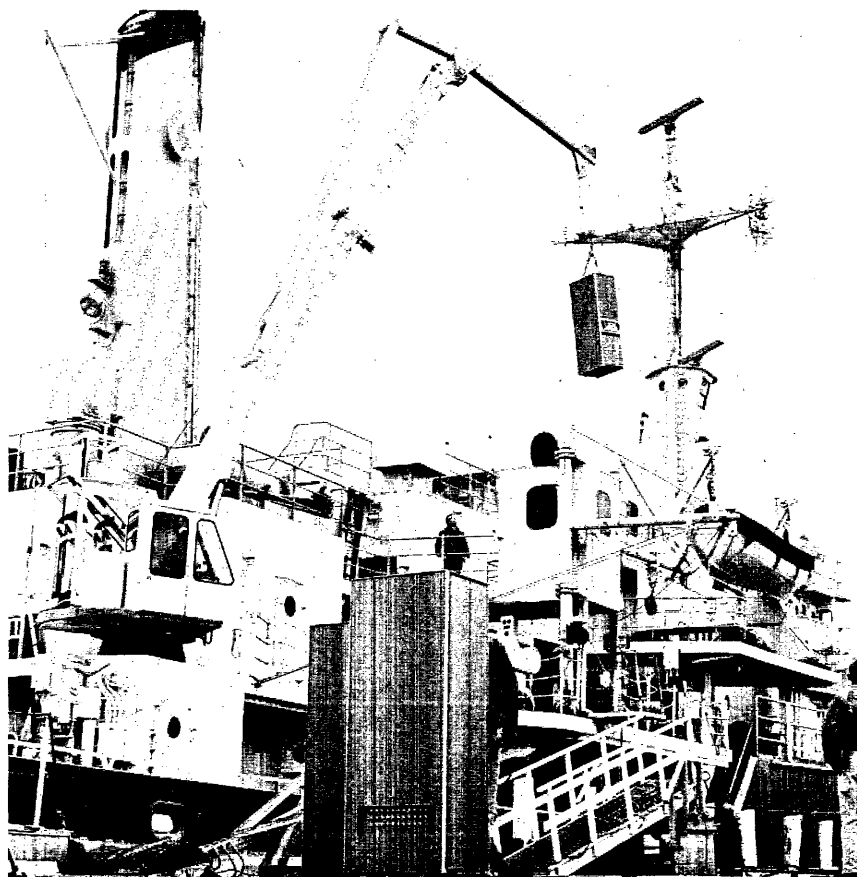

Pictured above is the PDP-5 being hoisted onto the Atlantis II. The Atlantis sailed on January 20th for a nine-month cruise of the Indian Ocean. The PDP-5 will be used on-line to collect, record and analyze oceanographic data.

## On-Line Computing Systems Symposium

A three-day symposium on a new kind of data processing will be held on February 2, 3, 4, 1965 at Schoenberg Hall, University of California. The symposium is being presented by the Department of Engineering and UCLA computing Facility and Engineering Extension, University of California Extension, Los Angeles, in cooperation with Informatics, Inc.

Speakers will be: Eugene Amdahl, Walter F. Bauer, Emil Borgers, Werner L. Frank, Harry D. Huskey, Glen D. Johnson, Marvin Minsky, Herbert F. Mitchell, C. B. Tompkins, John Morrissey, Donald Parker, David Pope, Simon A. Ramo, Arthur Rosenberg, David Savidge, Ivan E. Sutherland, and Richard Talmadge.

For additional information concerning the program and enrollment, call or write Engineering Extension, University of California Extension, Los Angeles, California 90024. Telephone (Area Code: 213) 478-9711 or 272-8911, Extension 7277 or 7178; TWX 213-390-3968.

### DECUS Brochure

A DECUS brochure giving full details about the Society and its membership is in the initial stages of publication. It is planned to include photos of computer installations of several of the DECUS members. If you would like to include your installation, please send photos to DECUS as soon as possible.

### Reply Cards

Attached to last month's DECUSCOPE was a reply card regarding DECUSCOPE distribution. Several cards were returned without the senders name. If you did not receive the proper amount of DECUSCOPEs this month, please contact A. Cossette at the DECUS office.

### LITERATURE AVAILABLE

#### PDP-5 Symposium Proceedings

Proceedings of the PDP-5 Symposium held at Berkeley, California in September are now being distributed. Copies are available from the DECUS office in Maynard.

#### Brochures

"630 Data Communication System"  
Revised Edition

"Multianalyzer Programming Handbook"

"Multianalyzer Spectrometer Control Brochure"

"Laboratory and Educational Modules Handbook" - B100

Installation DelegatesPDP-4

Mr. Richard J. Clayton  
Communications Biophysics Group, RLE  
Massachusetts Institute of Technology  
Cambridge, Massachusetts

PDP-5

Mr. John H. Bradshaw  
Physics Department  
Boston College  
Chestnut Hill, Massachusetts

Mr. David C. Coll  
Defence Research Telecommunications  
Establishment  
Ottawa, Ontario

Mr. Irving Fisk  
Investment Statistics Company  
San Francisco, California

Mr. Sidney Gear  
General Dynamics/Electronics  
Rochester, New York

Mr. James Miller  
Dow Badische Chemical Company  
Freeport, Texas

Dr. Dallas C. Santry  
Atomic Energy of Canada Ltd.  
Chalk River, Ontario

Mr. Paul Sternberger  
Dow Jones & Company, Inc.  
Princeton, New Jersey

Mr. Richard Taylor  
Bendix Corp. ASTR-6-ST  
Marshall Space Flight Center  
Huntsville, Alabama

PDP-6

Mr. William A. Love  
Physics Department  
Brookhaven National Laboratories  
Upton, New York

Mr. Richard K. Yamamoto  
Massachusetts Institute of Technology  
Laboratory for Nuclear Science  
Cambridge, Massachusetts

PDP-8

Mr. G. S. Woodson  
Space Physics Research Laboratory  
University of Michigan  
Ann Arbor, Michigan

Individual Members

Mr. David Friesen and  
Mr. Elhanan E. Ronat  
Massachusetts Institute of Technology  
Laboratory for Nuclear Science  
Cambridge, Massachusetts

Mr. Harris Hyman  
1 Lyndeboro Place  
Boston, Massachusetts

PDP-5 PROGRAM LIBRARY ADDITIONSDECUS No. 5-12

Title: Pack-Punch Processor and Reader for the PDP-5

Author: Robert L. Becker, Boston College

Abstract: The processor converts a standard binary-format tape into a more compressed format, with two twelve-bit words contained on every three lines of tape. Checksums are punched at frequent intervals, with each origin setting or at least every 200 words.

The reader, which occupies locations 7421 to 7577 in the memory, will load a program which is punched in the compressed format. A test for checksum error is made for each group of 200 or less words, and the program will halt on detection of an error. Only the most recent group of words will have to be reloaded. Read-in time is about ten percent less than for conventional binary format, but the principal advantage is that little time is lost when a checksum error is detected, no matter how long the tape.

DECUS No. 5-13

Title: PDP-5 Assembler

Author: Anthony Schaeffer, Lawrence Radiation Laboratory, Berkeley

Machine: IBM 7094/7044

Language: FORTRAN IV, MAP

Abstract: This program accepts symbolic programs punched on cards and assembles them for the PDP-5. An assembly listing is produced, and a magnetic tape is generated containing the program. This magnetic tape can be converted to paper tape and then read into the PDP-5, or it can be read directly into a PDP-5 with an IBM compatible tape unit. Cards are now available.

Note from the DECUS Programming Chairman - R. McQuillin

For the past several months I have had the opportunity to do programming for the PDP-5. This particular machine used the high speed reader and punch. In using PAL, (The December 1964 version) I have come upon several things in its operation that could perhaps be improved upon. In trying to write a rather elaborate type-setting system, I have placed all my common symbols and linkages on page zero. Thus everytime I assemble another page, I must merge page zero to the other page, and then run it through the assembler. It seems as though there are at least two ways out of all this paper handling. First: It is unfortunate that we can't read into the PAL Symbol Table directly, punch out PAL at this point, and then have this special version of PAL available for future use. In this way, I could get page zero into the PAL symbol table once and for all, and I wouldn't need page zero again as long as all the values stayed constant. Another solution to the problem would be a "pause" operator that would cause PAL to stop so another tape could be loaded into the reader. Depressing "continue" would cause PAL to clear its input buffer and resume the assembly. The second proposal is actually equivalent to the first. A feature of PAL that seems unusual is that a "start loading at 200" is always punched out first on the binary tape regardless of where the program is told to start. This seems to cause the loader to deposit 0000 in location 200 sometimes.

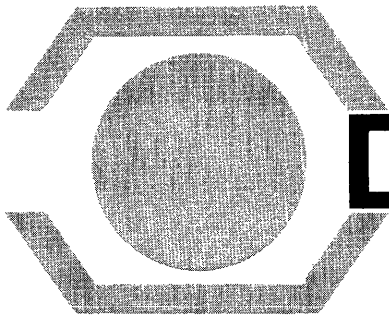

# DECUSCOPE

DIGITAL EQUIPMENT COMPUTER USERS SOCIETY  
MAYNARD, MASSACHUSETTS / TEL. 897-8821 / TWX 710 347-0212

FEBRUARY 1965

VOL. 4 NO. 2

DECUS  
SPRING SYMPOSIUM  
1965

## CONFERENCE ON DIGITAL COMPUTERS FOR COLLEGE TEACHERS OF SCIENCE, MATHEMATICS AND ENGINEERING

With financial assistance from the National Science Foundation, the University of Southwestern Louisiana will conduct on its campus its third Conference on Digital Computers for College Teachers of Science, Mathematics, and Engineering. This program will enable 40 participants (20 beginning, 20 advanced) who are college teachers in the above disciplines to acquire training and experience in digital computation involving high-speed, stored program, electronic computers. The Conference will be in operation from August 16 through September 6, 1965.

The Conference will include:

1. Two courses for each group: Introduction to Digital Computers and Programming Digital Computers (beginning); Numerical Analysis for Digital Computers or Statistics for Digital Computers, and Advanced Computer Programming (advanced).

Each course will involve daily class meetings of 3 hours each.

2. Computer demonstrations illustrating various facets of computer operation.
3. Laboratory participation in computer operation.
4. Seminars on recent developments in the field of computation.
5. Talks and discussions by visiting lecturers.
6. Informal conferences among participants and staff.

The Conference will be conducted by Dr. James R. Oliver, Dean of the Graduate School and Director of the Computing Center, University of Southwestern Louisiana. He will also teach and conduct the seminars.

Continued on Page 2

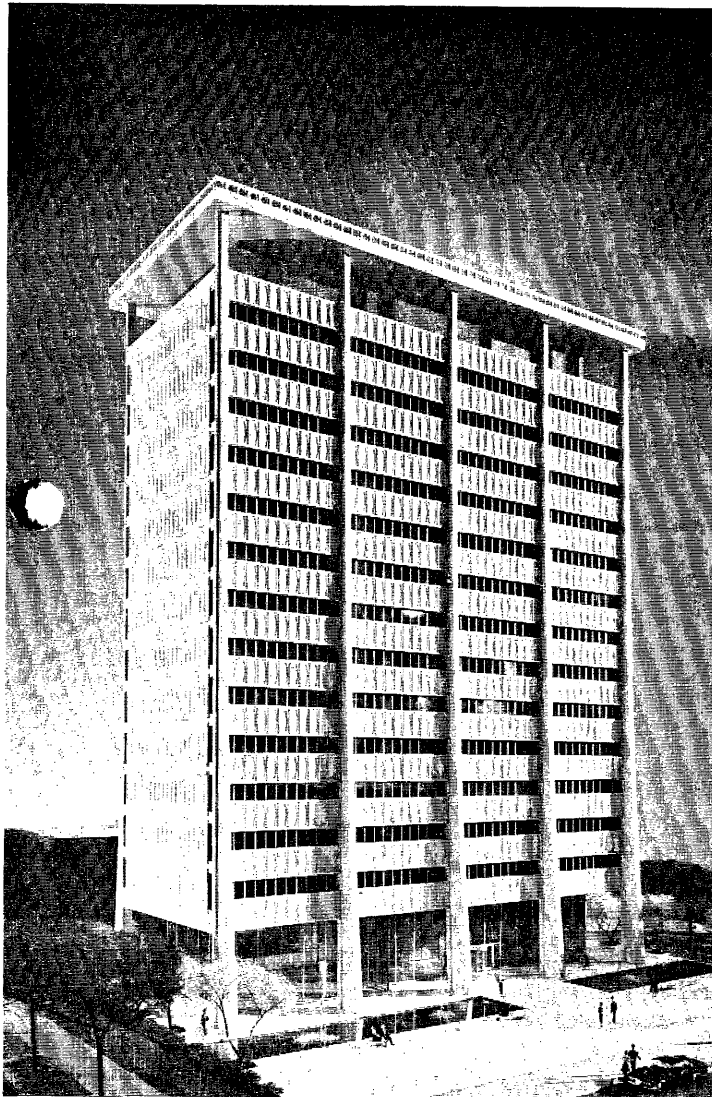

Pictured above is the new William James Hall, Harvard University, Cambridge, Massachusetts - the site of the 1965 DECUS Spring Symposium.

Plans are well underway for a very informative and interesting meeting. Abstracts of papers already received show a wide variety of subjects for presentation. If you are planning to present a paper, the deadline for abstracts is March 11. Mrs. Joyce Bradley, assistant to Dr. Norman, is doing a fine job of coordinating plans at Harvard. The dates of May 20 and 21 were chosen in order that persons planning to attend the INTERDATA 65 Show in New York beginning May 24 would have the opportunity of attending the DECUS

Meeting by just starting out a few days earlier.

Mr. Harlan Anderson, vice-president of Digital Equipment Corporation and Professor Steven Coons, Associate Professor of Mechanical Engineering at the Massachusetts Institute of Technology will be among the guest speakers. Highlights of the two-day meeting will include tours and demonstrations at the Center for Cognitive Studies, William James Hall, Project MAC and Adams Associates' facilities at Technology Square in Cambridge.

## Conference on Digital Computers Continued

A unique feature of the Conference will be the scheduling of seminars on time-sharing. This is expected to be an extremely important development in computers in the very near future. Through use of the Digital Equipment Corporation PDP-6 computer, made available by DEC for the Conference, and three remote terminals time-sharing demonstrations, studies and assignments will be included in the Conference.

Application for participation in the Conference will be made on forms provided by the National Science Foundation. The forms and brochures giving full details may be obtained by writing to:

Dr. James R. Oliver  
Box 133, USL Station  
Lafayette, Louisiana, 70506

The deadline for submitting applications for participation in the Conference is March 15, 1965.

## WHAT WILL THE WORLD BE LIKE IN 1975?

Thirty students at the University of Michigan know and are using their knowledge in an experiment that uses the PDP-1 and 340 Display.

The process of human inference is being studied by Dr. Ward Edwards and his associates in the University's Engineering Psychology Laboratory. They have invented a "history" of the world from the present until 1975, a history complete with economic, political, military and technological details. The experiment takes place on the third Tuesday in June, 1975, from 10 a.m. to 2 p.m., ESST. At that time, exactly one of six possible hypotheses about the condition of world affairs can be true. Subjects are given data which can be used to determine the correct hypothesis. However, since no datum is conclusive, the subjects can only be relatively more certain of some hypotheses than others. How this uncertainty is dealt with is the focus of the experiment.

In one form of the experiment, subjects move sliders calibrated in odds, like betting odds, to reflect their changes in uncertainty, or certainty, about which hypothesis is true. The PDP-1 converts the odds settings to probabilities, and displays these probabilities as bar graphs on the 340. Thus, subjects can see what effects the probabilities changes have in the odds settings. The 340 Display provides instantaneous feedback to the subject on the system's current opinion about which hypotheses are more likely than others.

Different versions of this experiment require subjects to estimate likelihood ratios, rather than odds, and a similar kind of feedback is shown on the 340.

In future experiments involving continuous hypotheses, subjects will express their uncertainty by forming probability distributions over the hypotheses. Parameters of the Beta distribution will be manipulated on the face of the 340 by using the light pen, and the resulting distribution will be displayed on the CRT.

All these experiments will shed further light on the proper roles for men and computers in diagnostic systems operating in the face of uncertainty.

Lawrence Phillips  
University of Michigan

## PDP-5 AT MENTAL HEALTH RESEARCH INSTITUTE

Dr. Utall's research group at the University of Michigan is currently involved in several studies of the somatosensory system, psychophysical and physiological, all of which are controlled by the PDP-5. Much statistical analysis is also done by the computer. For the purpose of our experiments, we use, in addition to the PDP-5, various electronic stimulating and recording equipment, including three oscilloscopes and peripheral computer I/O which we have added to the PDP-5. These additional I/O devices include an analog to digital converter, a one millisecond real-time clock, and a yes-no response key, among others. All these devices operate on an interrupt basis.

In one experiment, we are studying peripheral nerve action potentials in the human ulnar nerve. The computer triggers set patterns of electrical pulses and the resulting nerve responses are recorded on a storage oscilloscope. Polaroid pictures are made by a camera attached to the oscilloscope to enable subsequent study of these responses.

Another of the experiments in which we are currently involved concerns the effects of stimulus patterns on the ability of a subject to detect a temporal "gap" in that stimulus. This study is relevant to the coding of nerve messages. The computer sends two series of stimuli with a variable break between the two. On the basis of the subject's response as to whether or not he felt the break, the break is made longer or shorter by another variable amount which is calculated on the basis of the subject's previous responses at the end of a set number of such responses. A statistical analysis of the collected data is made by the computer.

A third experiment measures, by means of scalp electrodes, the brain waves evoked by alternate "shock" and light flash stimuli. Many samples are taken during each response and many responses are averaged together to screen out random electrical "noise." For final comparison, the final averages of the results of the two types of stimuli are displayed on a storage oscilloscope separately and then merged together and displayed. Polaroid photos are taken of the final results.

The last two experiments have been programmed on a time-shared basis to run simultaneously.

With the forthcoming addition of a magnetic tape drive to our system, we intend to expand our experimental program and increase our time-sharing capability.

### Acknowledgement:

I am grateful to Mrs. Madelon Krissoff, Dr. Utall's assistant, for her help in preparing this article.

Barbara Lamm  
University of Michigan  
Mental Health Research  
Institute

### EDITOR'S NOTE

An article on the PDP-4 at the Behavior Analysis Laboratory, University of Michigan has been published as an Application Note and is included as an insert to this issue.

# COMPUTER APPLICATIONS DIGEST

## NOTES FROM THE PROGRAMMING CHAIRMAN

On February 4, I attended a meeting of JUG, the Joint Users Group of the ACM, in New York City. The purpose of the meeting was to discuss the establishment of a new JUG-ACM publication, tentatively called the Computer Applications Digest. While the plans for such a publication are still incomplete, it seems probable that the digest will come out monthly with an annual compendium of the entire year's transactions. It is estimated that the monthly issues will be printed as inexpensively as possible, perhaps on newspaper stock. These issues will be distributed with the newsletters of each user's group, i.e. DECUSCOPE. At the end of the year, all the monthly newsletters, plus accumulated entries that did not get into the monthly issues, will be put together in a bound volume, along with an index.

The purpose of the Computer Applications Digest is to share current computer programming and current computer applications (program system) among the various computer user groups. Each contribution will be written up on a short form and will be submitted to the editor for that user's group. Each user group will have an editor who will pass on all contributions for that group. The short form will be similar to the short form DECUS uses, but written up in such a way to be useful to users of other machines. It is these short forms that are published, the more detailed documents, tapes, cards, etc., remaining in the user library. Requests for more information will be made to the user group editor directly.

The Computer Applications Digest is seen to fill a need in the computing profession. At present there is precious little being communicated between users of computers. Certainly one is hard put to find out what is going on in the computing fraternity by reading the official publications of the ACM. It is felt that JUG is in a unique position to sponsor such a project as the Computer Applications Digest. Of course, the success of the endeavor depends on the support of the individual user groups, such as DECUS. From the point-of-view of DECUS, this new publication offers a chance to be in more direct contact with a great many more users, such as those in SHARE, GUIDE, SDS, etc., and to get recognition for our work in the entire computing community. With the trend to standardization of languages among computer

manufacturers, we hope that eventually computer programming systems can pass directly from one user's group to another. If there are any questions or comments to this new venture, I would be most happy to receive them and to pass them along to the proper people at JUG.

Richard J. McQuillin

## NEW DECUS MEMBERS

### DELEGATES

#### PDP-4

William G. McNamara  
Westinghouse Electric Corporation  
West Mifflin, Pennsylvania

#### PDP-5

Dorothy Nelson  
Stanford Research Institute  
Radio Physics Laboratory  
Menlo Park, California

David M. Carlson  
Professional Data Services  
Ann Arbor, Michigan

Eli Glazer  
Brookhaven National Laboratories  
Physics Department  
Upton, New York

C. B. Bigham  
Atomic Energy of Canada Limited  
Chalk River, Ontario, Canada

#### PDP-7

Ralph R. Fullwood  
Rensselaer Polytechnic Institute  
LINAC Laboratory  
Troy, New York

### INDIVIDUAL MEMBERS

J. Martin Graetz  
9 Sycamore Street  
Cambridge, Massachusetts

Robert L. Kusik  
Rutgers University  
New Brunswick, New Jersey

M. Sandra Morse  
University of Maryland  
Baltimore, Maryland

# NEWS ITEMS

## Applications

### LINC AT WORCESTER FOUNDATION

The Worcester Foundation for Experimental Biology at Shrewsbury, Massachusetts, has purchased a LINC computer for experimentation in its Laboratory of Neurophysiology.

The foundation carries out research and experimentation concerned with the chemistry and physiology of the body. Its staff numbers approximately 340, with 130 holding the Ph.D. or M.D. degrees.

LINC is the Laboratory INstrument Computer designed at Massachusetts Institute of Technology and available through Digital Equipment Corporation. Its development program was supported by the National Institutes of Health, first at M.I.T. and now at Washington University in St. Louis.

The Worcester Foundation will use LINC to investigate electrical nerve messages in the brain which determine behavior. It will be used with various data gathering apparatus, including the electroencephalograph and other electrical recording devices, to study spontaneous and evoked brain potentials in the cerebral cortex and other brain areas.

As well as being used in conventional signal-recording and signal-processing applications, it will also function as a monitor of signals from the sensory organs to the brain and from the brain to the muscles. In these studies it will become a functioning part of an actual biological system to give the researchers more of an insight into how the system operates. In addition to monitoring the signals, it will be able to delay, diminish, and intensify them or generate artificial ones to let researchers observe their effects.

LINC has a random access core memory of 2048 12-bit words which cycles in 8 microseconds. Its 16 analog-input channels accept up to 30,000 signals per second, convert them into digital numbers, and store them in memory. Its 48 instructions perform high-speed multiplication, tape operations, and other arithmetic and logical functions.

It includes a built-in cathode ray tube display for viewing signals, a small magnetic tape system for efficient data and program storage and manipulation, and an input keyboard to let the user type data and commands directly into the computer.

### BELL TELEPHONE TO USE PDP-7 FOR CIRCUIT TESTING

Bell Telephone Laboratories of Murray Hill, New Jersey will be using the PDP-7 for use in development of an automated computer controlled measurement system. The system will be used in loss and phase measurements ranging from 50 cycles to 250 megacycles.

Included with the PDP-7 in this system will be a 4096-word memory, 300-character-per second paper tape reader, 63-character-per-second tape punch, information collector, three digital-to-analog converters, control and buffers for the plotters, device selector, and output buffers with relay drivers.

### PDP-7 AT MASSACHUSETTS GENERAL HOSPITAL

The Psychiatry Department of Massachusetts General Hospital will be using a PDP-7 computer for clinical and laboratory analyses in applications ranging from brain surgery to protein crystal studies.

The PDP-7 will be used primarily in on-line experiments, recording and analyzing data, performing preliminary evaluations of data to determine its validity for further processing, and, in some cases, controlling experimental procedures.

Some of these experiments are an investigation of unit cell activity in the visual cortex of the brain, electroencephalographic analysis of patients with Parkinson's disease, analysis of endocrine system functions, and locating brain tumors.

The hospital had earlier used the PDP-4 computer. Since the PDP-7 is program-compatible with the PDP-4, the specialized programs developed by the hospital, as well as the general purpose software, can be used on the new machine.

Included in the PDP-7 for Massachusetts General Hospital will be the processor, 8192-word memory, extended arithmetic element, cathode ray tube display and light pen, analog-to-digital converter with 8-channel multiplexer control, dual digital-to-analog converters, and a Dual DECTape Transport and Control.

### MODIFICATION TO INTENSITY CONTROL OF CRBG TYPE 30 DISPLAY

A modification to correct condition of darker levels of intensity being stretched, and brighten levels being compressed was performed on the Type 30 Display by CRBG personnel at Air Force Cambridge Research Laboratories.

The original intensity control is performed using three flip-flops to give 8 levels of intensity. This is done by equal voltage steps, and unfortunately does not account for non-linear transfer curves of the amplifier, the CRT, and sight or film.

To compensate for these non-linear characteristics, a binary to actual decoder was used to select one of eight fines for each of the flip-flop states. The over-all effect being that all eight intensity levels are easily and more readily discernable.

For further information you may contact:

Mr. John Mott-Smith or  
Mr. Floyd H. Cook  
Synthetic Coding Branch  
Data Sciences Laboratory  
L. G. Hanscom Field  
Bedford, Massachusetts

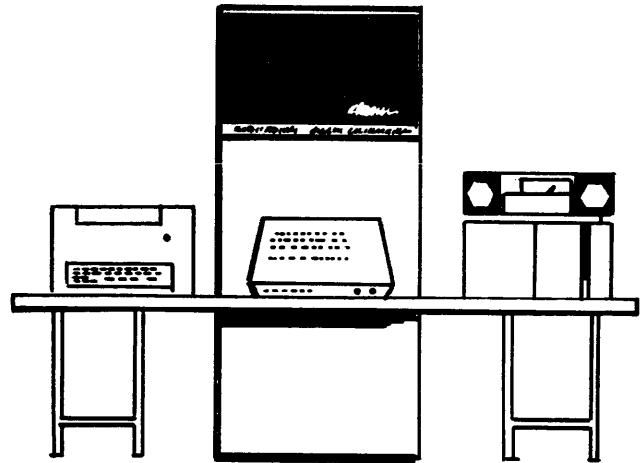

**PDP  
4**

**COMPUTER  
APPLICATION  
NOTE**

**EXPERIMENTAL SYSTEM  
GIVES LANGUAGE STUDENT  
INSTANT ERROR FEEDBACK**



## COMPUTER SERVES AS TEACHING MACHINE

The Behavior Analysis Laboratory of the University of Michigan is using a general-purpose Programmed Data Processor-4 (PDP-4) and other equipment built by Digital Equipment Corporation of Maynard, Mass., as a teaching machine for a series of speech experiments.

The research activity in which the system is used is intended to determine the effectiveness of teaching accuracy and fluency of expression in a second language by machine. It is the first such program to give the student instantaneous error feedback from a machine which performs error discrimination. The program is directed by Dr. Harlan L. Lane of the university's Department of Psychology. Roger L. Buiten is the project engineer appointed to implement the device.

Because it is considered basic psychological research, no cooperative activity has been planned yet. Initially, the investigators are attempting to learn only whether such a system can work effectively. If it can, such applications as language teaching and speech impairment correction could be pursued with other departments.

The teaching machine, shown in the accompanying diagram, is intended to train a student in speaking a second language properly. He must have studied the language for a year or two, giving him some command of vocabulary and grammar. The machine drills him on the correct intonation, loudness and rhythm of the spoken words.

The system presents to a student some model phrases and sentences in a second language in samples up to a minute long, recorded on tape by a proficient linguist. The system processes the model sentence while the student is listening to it. When he attempts to duplicate the pronunciation and delivery, the meters will show him how his utterance departs from the model. Simultaneously, the computer calculates a running sum of his errors to determine whether his performance falls within acceptable limits. Associated circuitry causes the recorder to replay the sample until he imitates it acceptably.

The project is called SAID, for Speech Auto-Instructional Device. It is based on a three-year research program at the laboratory to determine how sentence and phrase construction can be characterized. Pitch, amplitude and tempo were found to be the only

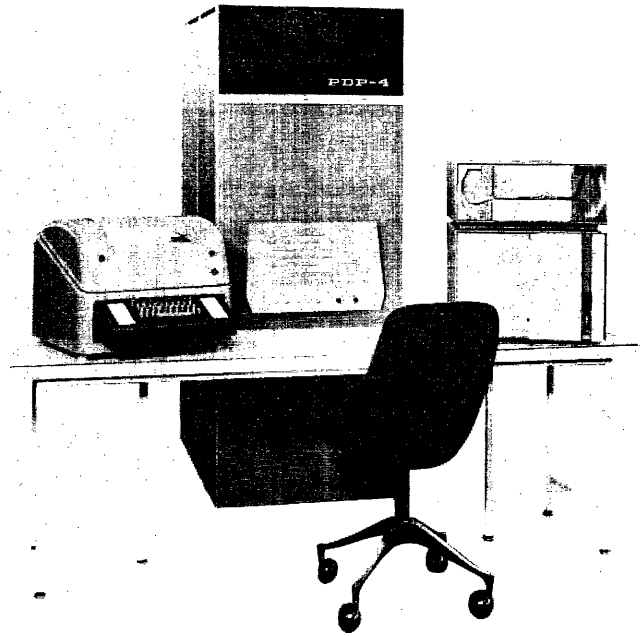

The PDP-4 is an 18-bit computer designed for scientific, engineering, and process control applications. It performs 1's or 2's complement binary arithmetic at a rate of 62,500 additions per second. Core memory, ranging from 1024 to 32,768 words, cycles in 8 microseconds, giving it an input/output transfer rate of 125,000 words per second.

measurable variables. Pitch is a continuously extracted fundamental frequency sampled 500 times a second. Amplitude is the instantaneous peak voltage of the speech waveform sampled 500 times a second. The pitch and amplitude extractors were developed for the program by the university's Communication Sciences Laboratory. Tempo is synthesized by the PDP-4 from the spacing between pulses generated each time a peak occurs in the average speech power output. A tempo reading is taken for each peak amplitude.

The analog-to-digital converter accepts the outputs of the pitch and amplitude extractors, converts the values into digital numbers, and presents them to the PDP-4 computer. It includes a second comparator circuit, where the input analog voltage is compared with the trial digital value. The second comparator permits the converter to perform its own multiplexing simply and economically. The converter includes front-panel switches to let the user vary digital word length from 6 to 11 bits and to vary switching point accuracy from 98.4 to 99.05 per cent.

The PDP-4 accepts pitch and amplitude samples of the tape-recorded model's parameter contours, time-codes them, synthesizes tempo, and stores enough samples in memory to reconstruct the contours. When the student repeats the phrase, the computer compares samples of his contours with those in memory and subtracts the curves to generate error signals. Eight-bit digital-to-analog converters transform the computer outputs to drive the meters.

With sentences on the tape up to a minute long, up to 2048 registers of the PDP-4's 4096-word memory are devoted to sample storage. The balance of the memory holds the program instructions, which can be varied at will to perform new functions. Another planned use for the computer is for generating

stimuli in psychoacoustical experiments requiring precise changes in level, frequency, and timing. Additionally, it will also be used to analyze and evaluate the results of experimentation throughout the Behavior Analysis Laboratory.

A special-purpose device could hardly be designed to perform some of the functions the PDP-4 will handle, it would lack the versatility of the general-purpose computer, and it would probably be idle an appreciable time between experiments. The PDP-4, however, gives the laboratory its own powerful computation capability, being able to convert quickly, without hardware changes, from controlling and recording an experiment to analyzing its results.

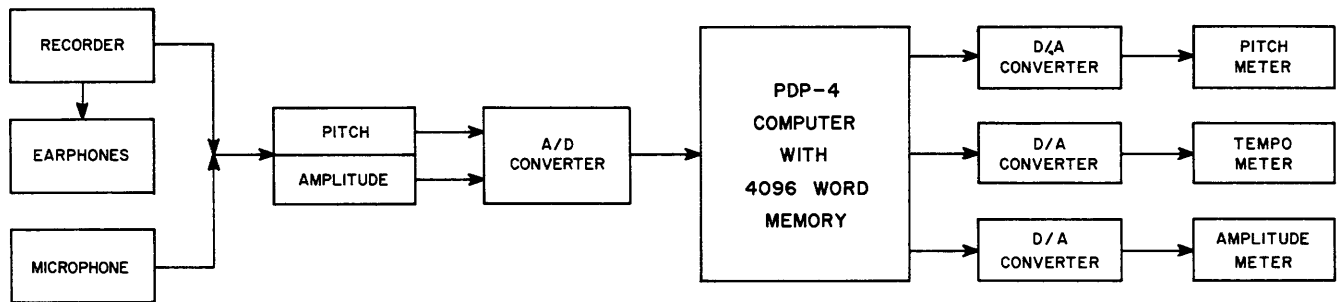

The Project SAID teaching machine includes an analog-to-digital converter, general-purpose Programmed Data Pro-

cessor-4 computer, and digital-to-analog converters built by Digital.

**digital**

## PDP-4 COMPUTER REDUCES MODULE TESTING TIME 90%

Circuit module testing procedures which take hours to perform manually and minutes with semi-automatic equipment are reduced to seconds - 50 milliseconds per dc test, 100 milliseconds per ac test. All 45 required tests in less than 6 seconds per module.

Key to the Tester's speed and versatility is the PDP-4 computer. Acting as the control element, it determines the tests to be made, collects measured information from the Tester, compares, interprets and distributes it to output devices.

The flexible, high-capacity, input-output capabilities of the PDP-4 enables it to operate in conjunction with a variety of peripheral devices. Complete control is provided for 8 input and 8 output devices which can be readily expanded. By merely changing its programs, the PDP-4 can handle virtually any automatic checkout procedure.

This system has been in use at Digital Equipment Corporation to check out DEC's line of system modules and the new line of flip-chip modules.

A brochure giving further details is available.

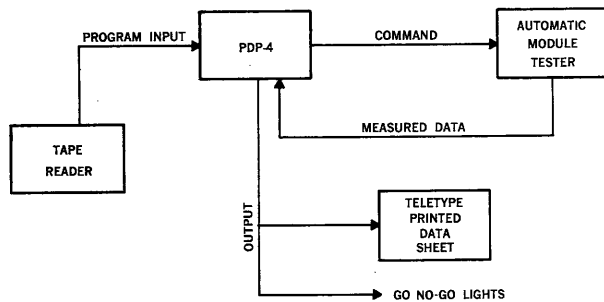

AUTOMATIC MODULE CHECKOUT SYSTEM

## Programming

PDP-5/8 FORTRAN SYMBOLPRINT and a New Use of the PAUSE Statement in 5/8 Fortran

From: James Langley, Digital Equipment Corporation

"Fortran SYMBOLPRINT is a useful aid for those who want to know where their Fortran program is in interpretive memory, the exact memory locations assigned to each Fortran variable and the amount and location of interpretive core memory that is actually unused by a Fortran program.

SYMPNT is loaded over Fortran after compilation and started at address 600. A typeout such as the following (but minus 'headings') occurs after some internal deliberation.

Example output:

<u>List of Variable Names</u>	<u>Assigned Location</u>
.	.
.	.
.	.
HW	7546
TB	7543
G	7540
TF	7535
MC	7534
DSR	7531
C1	7526
C2	7515
C3	7504
C4	7470
.	.
.	.
.	.
6312	7241

Note that a single word only has been assigned for the fixed point variable MC.

The last two octal constants typed indicate respectively the highest address used by the program in interpretive memory and the lowest address used for data. The area of core between these two addresses is therefore available for use. In the example there are

$$7241 - 6312 = 727$$

octal locations free.

A machine language program may be inserted in this space and linked to the Fortran program by using the Fortran PAUSE statement.

If PAUSE is followed by a number (considered to be DECIMAL), an effective JMS is created to that address.

for example:

;PAUSE 3328  
will create, effectively, JMS 6400. At 6400 there would be something similar to:

```

SUBR, 0
:
:
:
JMP I SUBR
  
```

You can exit from Fortran to machine code and then return to Fortran."



## BUSINESS PACKAGE II (BUS-PAK II)

By: C. B. Colicelli, Digital Equipment Corporation

Bus-Pak II, in essence, is a new computer language designed for data processing operations. It operates on a character by character basis and its instructions are powerful and easy to learn and understand. Bus-Pak II offers a variety of powerful programming features such as Editing, Two Modes of Indexing and Complete Input/Output Control. The Bus-Pak II programming system was developed so that many of the manual record keeping and updating operations could easily be converted to make use of the PDP-4 or PDP-7 computing system. Bus-Pak II users need not be aware of all the computer intricacies. Through the use of the pseudo-language, one can accomplish most of the functions of a business oriented computer including the handling of the peripheral in-out equipment.

The manual, which has just recently become available, has been written so that programmers with minimum experience will be able to learn and understand the Bus Pak II Programming Language.

Reference may also be made to either the PDP-4 or PDP-7 Assembler write-ups, but is not a necessity.

Subroutines and other programs written in machine Assembler language may be used within a Bus-Pak II program provided that the programmer saves the accumulator before execution of a Bus-Pak II instruction, and restores it when re-entering the machine language program where necessary.

The Bus-Pak II Programming System will operate on either a PDP-4 or PDP-7 with the following configurations:

### Standard Equipment

8K Core Storage  
Paper Tape Reader-Punch  
Teletype Input-Output and  
At least 1 input and 1 output unit shown below

### Optional Equipment

Card Reader  
Card Punch  
Magnetic Tape  
DECtape  
High Speed Printer

## ✱ DECTAPE APPLICATION NOTE PDP-5/8

From: Russ Winslow, Digital Equipment Corporation

### "Bouncing" Off The End Zone To Read or Write Block 0 or Block N + 1

When an end zone is encountered (time zero), the DECTape control behaves as if an MMLM command has been issued with the contents of accumulator bit 7 a zero. A zero is forced into the motion flop, status bits 1 and 2 are set, the error flag is set and a 35 millisecond delay is initiated.

At time zero + 35 milliseconds when the delay times out, the contents of the motion flop (0) is forced into the GO flop and a second 35 millisecond delay is initiated.

At time zero + 70 milliseconds the second delay times out and the DT flag is set. This is a signal to the program to institute turn around action via an MMMF command. By waiting until this moment (time 0 plus 70 milliseconds) to institute such action, the program is assured that the DECTape control will "open its eyes" in time to read the block number

of the end block and effectively read from or write onto it. If no such action is taken, of course, the tape will come to a stop automatically.

## Literature Available

"Data Control Type 136" - H-136: Describes installation, operation, and maintenance of the 136, a programmable buffer unit through which the PDP-6 processor can control up to six input-output devices.

"Magnetic Testing Application Note No. 8 - Protection of Solenoid Drivers"

"DECTape Brochure F83(555/552)" is now available through the DEC Sales Office in your area. The new brochure is completely revised for the PDP-5/8 and 552 Control.

New Bulletin - F-83(580) - Describes the Type 580 Magnetic Tape System for the PDP-8.

## REPRINTS

"Computers in the Nuclear Station"

by: C. G. Lennox and N. P. Vakil  
Reprinted from Canadian Controls & Instrumentation

The article is a description of a large-scale computer control experiment at Chalk River and details on the CDC 363 installation at 200 MW Douglas Point Station.

## FROM THE DIGITAL PROGRAM LIBRARY

Manual and tapes on the following PDP-7 programs are available:

Symbolic Tape Editor	(Digital-7-1-S)
FORTRAN II System - 8K	(Digital-7-2-S)
Assembler - Basic and Extended	(Digital-7-3-S)
DDT - Basic & Extended	(Digital-7-4-S)

Tapes Only:

Teletyp Output Package	(Digital-7-10-O)
Tic-Toc	(Digital-7-11-IO)
Floating Point Package	(Digital-7-30-A)
Master Tape Duplicator	(Digital-7-40-U)

Tapes are presently on hand and the write-ups will be ready within the next week or two on the following:

For machines with DECTape:

DECTog	(Digital-7-20-IO)
DECTrieve	(Digital-7-21-IO)
DECTape Subroutines	(Digital-7-22-IO)

For machines with Mag Tape:

Type 57A Compiler	(Digital-7-45-U)
-------------------	------------------

Software for maintenance:

Teleprinter Input-Output Test	(Digital-7-50-M)
PDP-7 EAE Checker	(Digital-7-58-M)

# DECUS PROGRAM LIBRARY

## PDP-5 PROGRAM LIBRARY CATALOG ADDITIONS

### DECUS NO. 5-14

Title: Dice Game for the PDP-5  
Author: Edward P. Steinberger, Digital Equipment Corp.

Binary tapes and write-ups are available.

### DECUS NO. 5-15

Title: ATEPO (Auto Test in Elementary Programming and Operation of a PDP-5 Computer)  
From: Rutgers-The State University, Electrical Engineering Department

Abstract: The program will type questions or instructions to be performed by the operator of the PDP-5 (4K) computer. The program will check to see if the operator has followed the instructions or has answered the questions correctly. If this is the case, it will type the next question or instruction.

Characteristics: The starting address of the program is 200(8). The program itself uses the locations 200(8) to 500(8), and the messages to be typed are in 600(8)-3410(8). The area 300(8)-577(8) is used to store the Rim and Bin loaders while the program is running. Page 0 and the locations above 4000(8) are a "work area" in which all the instructions are going to be executed, and in which the operator can make practically all kinds of mistakes, because the contents of the locations in that area are reset after typing any message. The program requires the Rim and Bin loaders to be in locations 7700(8)-7777(8) in order to transfer to the "safe area."

After using the program, the loaders can be returned to their original position by just starting the computer in location 377; it will jump to a small subroutine in 3500(8)-3515(8) that will make the transfer. The possibility of mistakes that would interfere with the program itself is reduced to practically zero, if the bit 0 is permanently kept (except when answering question 4) in the position 1. With the exception mentioned above, all of the other solutions can be accomplished with the bit 0 in position 1. For that reason, we strongly recommend that a piece of tape, or something similar, be put over the switch corresponding to that bit when being used by an operator without experience, for whom the program was designed.

### DECUS NO. 5-16

Title: Tape Duplicator for the PDP-5/8  
Author: Henry Burkhardt, Digital Equipment Corporation

Abstract: The tape duplicator for the PDP-5/8 is a single buffered read and punch program utilizing the program interrupt. It computes a character count and checksum for each tape and compares with checks at the end of the tape.

Checks are also computed and compared during punching. There are three modes of operation:

- A. SWITCH 0 ON - MAKE MASTER TAPE
- B. SWITCH 1 ON - DUPLICATE MASTER TAPE
- C. SWITCH 2 ON - VERIFY DUPLICATION

During duplication, the program will notify the operator whether or not more copies can be made without re-reading the master. Binary and symbolic tapes are available.

## WANTED

Fixed Point Sine/Cosine Subroutine with table look-up - faster than 10 milliseconds - for the PDP-4

Please contact Jon D. Stedman, UCLRL, Berkeley, Calif.

\*\*\*\*\*

This space is reserved for you. If you need a subroutine or program, why not let DECUSCOPE do the work of locating it for you. Send in your requests to DECUS today!



## COMPUTER OPTIONS

### TYPE 18 EXTENDED ARITHMETIC ELEMENT

The Extended Arithmetic Element (EAE) Type 18 is a standard option for Programmed Data Processor-4 to facilitate high speed multiplication, division, and shifting. The EAE contains an 18-bit register, the Multiplier-Quotient (MQ), a 6-bit register, the Step Counter (SC), and a 3-bit Instruction Register. The contents of the MQ are continuously displayed by indicator lights below the AC indicators on the operator console.

Some EAE instructions require 1 cycle (8 microseconds), while others allow the SC to specify the number of repetitive operations and require from 2 to 20 cycles. All cycles but the first are interrupt cycles of a priority higher than Program

Interrupt or Clock Counting, but lower than Data Interrupt. During the extra cycles, data may enter and leave the computer via Data Interrupt cycles. The EAE instruction will be delayed if necessary to allow the data transfers.

The EAE contains two one-bit sign control registers. The EAE AC Sign Register may be microprogrammed to contain the sign of the AC prior to a multiply or divide operation. The Exclusive OR of the EAE AC sign and the Link are placed in the EAE Sign Register. The EAE AC sign specifies the sign of the remainder when a divide instruction is complete.

The second sign control register, the EAE Sign Register, is set up prior to a divide or multiply instruction. It contains the sign of the quotient or product at the completion of the instruction.

#### TYPE 143 AUTOMATIC PRIORITY PROGRAM INTERRUPT

The Automatic Priority Program Interrupt Type 143 increases the capability of Programmed Data Processor-4 to handle transfers of information to and from input-output devices. Specifically, the 143 identifies the interrupting device directly, without searching for flags, and it allows a device of higher priority to supersede an interrupt already in progress. These functions increase the speed of the input-output system and simplify programming for it. More devices and/or higher speed devices can be efficiently serviced.

The system contains 16 automatic interrupt channels arranged in a priority chain. Each channel is assigned a unique fixed memory location and each in-out device is assigned a unique channel. The priority chain guarantees that if two or more in-out devices request an interrupt concurrently, the system will grant the interrupt to the device with highest priority.

The program interrupt system may operate in either of two modes, the Multi-Instruction Subroutine mode or The Single Instruction Subroutine mode. The mode is determined by the instruction in the memory location assigned to the channel.

THE MULTI-INSTRUCTION SUBROUTINE MODE is generally used to service an in-out device that requires control information from the PDP-4. Such devices would be alarms, slow electro-mechanical devices, Teletypewriters, punches, etc. Each device requires a servicing subroutine that includes instructions to manipulate data and give further instructions, such as continue, halt, etc., to the interrupting device.

THE SINGLE INSTRUCTION SUBROUTINE MODE. In some instances it is desirable for the PDP-4 to receive information from an external device, but not send control information to the device. Such an application would be the counting of real time clock outputs to determine elapsed time. The Single Instruction Subroutine mode of operation allows the incrementing of a counter to take place with a minimum of programming effort.

#### TYPE 132 CLOCK MULTIPLEXER

The Clock Multiplexer Type 132 permits the use of 16 memory registers ( $40_8 - 57_8$ ) in Programmed Data Processor-4 as 18-bit counters. Maximum combined counting rate is 125,000 per second. A priority addressing system for all 16 counts enables the multiplexer to handle simultaneous incoming pulses. Each incoming Standard DEC 0.4  $\mu$ sec pulse is registered in 8  $\mu$ sec.

## OTHER EQUIPMENT

### FLIP CHIP MODULES

DEC FLIP CHIP modules come in four series, including basic 0-2 megacycle DTL silicon logic circuits, basic 0-10 megacycle silicon circuits and silicon analog-digital units.

FLIP CHIP modules are one of three compatible lines of digital logic modules manufactured by Digital Equipment Corporation. System Modules cover the frequency range 500 megacycles and include many types of circuits to meet virtually every design need. They are described in the System Module Catalog (C-100). Laboratory Modules are packaged for frequent handling and repeated interconnection. Labeled, front-panel jacks make them useful for training purposes. They are described in the Laboratory Module Catalog (B-100).

System and Laboratory modules are compatible with FLIP CHIP modules and with each other. This means that all logic levels and power supply voltages are the same, and that all use static logic; that is, each module can operate at any frequency from zero to its maximum. Modules of different maximum speeds can be easily intermixed.

The System and Laboratory Module Catalogs are presently available from Digital Equipment Corporation. The FLIP CHIP catalog will be available in mid-March.

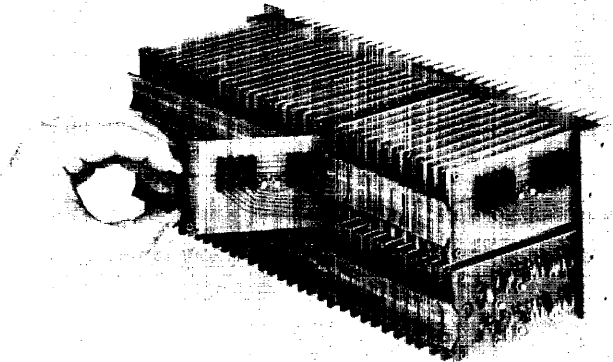

DECUSCOPE is published monthly for Digital Equipment Computer Users Society (DECUS), Maynard, Massachusetts.

Material for DECUSCOPE should reach the Editor before the 7th day of the current month for publication in that issue. Material received after the 7th will be considered for publication in the months following.

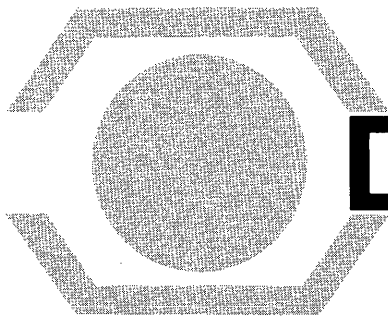

# DECUSCOPE

DIGITAL EQUIPMENT COMPUTER USERS SOCIETY  
MAYNARD, MASSACHUSETTS / TEL. 897-8821 / TWX 710 347-0212

MARCH 1965  
Vol. 4 No. 3

## SYSTEM FOR THE RECORDING, PROCESSING AND EXCHANGE OF LIBRARY CARD DATA

By: Lawrence Buckland, Inforonics Inc.

A PDP-1 system has been developed for the recording, processing, and exchange of library catalog data. The purpose of the development of such a system is twofold: 1) to mechanize some of the manual processes which are performed presently in libraries, and 2) to share digital record of library card data between libraries so that duplication of cataloging effort is eliminated. These objectives, if obtained, would save costs which could better be expended elsewhere for improved book collections and reference services.

The PDP-1 system is programmed to process the card catalog data. Its functions are to:

1. edit and correct recorded data
2. process card data to produce multiple cards in different formats
3. process card data to control automatic typesetting of cards
4. process data to form magnetic tape catalog file for loan and distribution.

One unusual aspect of the processing is the handling of non-Latin signs and symbols. These symbols are encoded so that in the output processing they can be typeset on the cards, or converted to an equivalent symbol printer of lesser symbol capacity, or left blank for hand entry.

### DATA RECORDING

The key idea in the whole system is the recording of data in machine readable form, because this is the only way to process it automatically. The process of recording in machine form is an expensive one for it requires accurate typing of complex bibliographic text matter. It is estimated that it would cost 5 million dollars to convert the catalog of the Library of Congress to machine readable form.

The approach mentioned here is to lessen this cost by creating a data recording process which is similar to the natural typing of ordinary catalog cards. This approach uses typing which is more efficient than card punching for recording text with upper and lower case characters. In addition to encoding the characters used in the bibliographic data, each of the

items on the card must be identified; for example, the author must be distinguished from the title.

This identification coding is accomplished by typing the data in a special format and using the space, tab, and carriage return codes which position the item in its proper sequence on the card. A special form can be designed which uniquely identifies bibliographic items in this manner. Such a typing format is shown in Figure 1. The advantage of this form is that skilled typists can prepare data for the system without special training. With library and other text processing systems such as publishing, the original creation of data often takes place on a typewriter. If the data encoding is separated from the data generation, the cataloger is prohibited from encoded data and the additional cost of a second typ-

ing is incurred. The items identified in the machine record are shown in Figure 1.

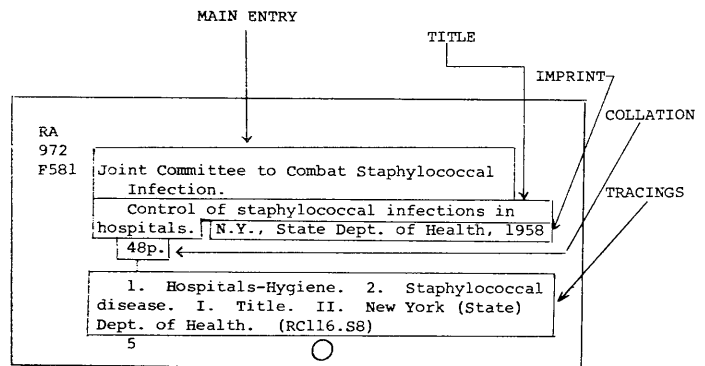

Figure 1 Input Typing Format

\* This paper was presented at the Spring 1964 Decus Symposium and published in the 1964 Decus Proceedings.



## System For Recording Library Card Data Continued

### PROCESSING

Once a record of the bibliographic data is created in machine form, a large number of potential uses of the data become feasible. The extent to which the machine record can be used has not been explored thoroughly, however there are some immediate requirements.

### CATALOG-CARD-PRODUCTION

Existing manual catalog systems produce multiple copies of catalog cards by manual typing. This can be mechanized by a simple computer program which selects reformatting items from the card. Figure 2 shows the cards produced by this program. Each of the tracings is selected and used as a filing entry at the top of the card.

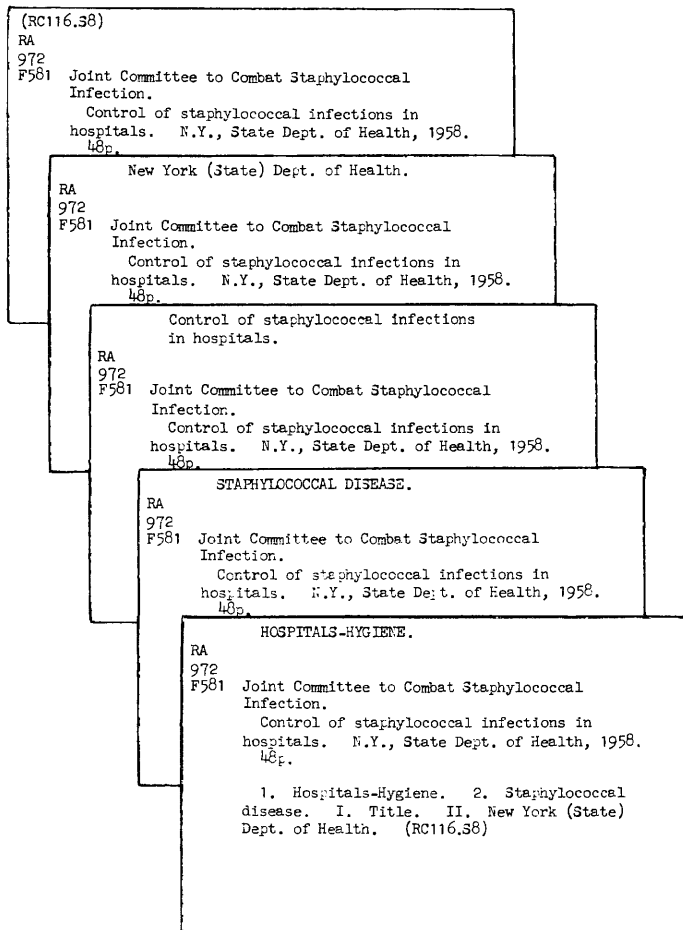

### BOOK CATALOG PRODUCTION

A second use of catalog data processing is in the production of book catalogs. These can be complete catalogs containing all bibliographic data, or shortened catalogs on a specified subject. The automatic production of these catalogs is a valu-

able tool because it will facilitate the production and distribution of references to special collections which exist in many large research libraries throughout the country.

### GENERATION OF DATA AT CENTRAL CATALOG SOURCE (LIBRARY OF CONGRESS)

The basic recording and processing concept described here has been applied on an experimental basis to the Library of Congress. The Library of Congress is the largest library in the country. The Library of Congress is anxious to satisfy the machine readable data needs of others.

The requirements for creating Library of Congress catalog cards are more elaborate typographically but the same data recording concept is useful.

U.S. President, 1961— (Kennedy)  
Program for education. Message relative to a proposed program for education, and a draft bill to strengthen and improve educational quality and educational opportunities in the Nation. [Washington, U.S. Govt. Print. Off., 1963]  
68 p. 24 cm. (88th Cong. 1st sess. House of Representatives. Document no. 54)  
Caption title.  
1. Education—U.S.—1945 I. Title. (Series: U.S. 88th Cong., 1st sess., 1963. House. Document no. 54)  
L111.C5 1963 370.973 63—60561  
Library of Congress

Copy of Library of Congress style catalog card typeset automatically from the input perforated tape record. The tape produced from typing the recording form was processed by a digital computer, producing a second tape which controlled the phototypesetting machine. The output of the phototypesetting machine is the card shown.

\* \* \* \* \*

DECUSCOPE is published monthly for Digital Equipment Computer Users Society (DECUS).

Material for DECUSCOPE should reach the editor before the 7th day of the current month for publication in that issue.

DECUSCOPE is published in Maynard, Massachusetts.  
Editor: Angela Cossette, Digital Equipment Corporation  
Publications Chairman: Joseph Lundy, Inforonics, Inc.  
Present Circulation: 1000 copies per month

# PDP-5 AT DOW BADISCHE CHEMICAL COMPANY

By: James Miller, Dow Badische

Dow Badische is a producer of bulk chemicals sold to other manufacturers. The company is using a 4K PDP-5, Type 555 Microtape System with two tape transports and a 630 Data Communication System with 5 Teleprinters operating remotely.

The computer system performs the following tasks:

1. Daily reports of raw material use, production, inventory of finished product and yields are generated remotely in the five areas having remote teleprinters, some with FORTRAN programs and some with time-sharing programs.
2. A number of engineering design calculations are handled at the local teleprinter using FORTRAN.
3. When the computer is otherwise not in use the teleprinters are used simultaneously as calculators which retain previously calculated values and do such operations as square root.

Paramount in the Dow Badische computer program is the effort to have all technical people intimately acquainted with the computer and able to use it. Many classes, exercises and workshops have been held concerning FORTRAN, PAL, microtape use and time-sharing programming. A special "time-sharing language," made possible by the new PAL, has been developed and taught and a manual produced to promote time shared use.

Near Future plans in the works include:

1. A device for reading into the computer memory from a remote station two plastic cards embossed and punched in Hollerith code, plus variable data as a means of accounting for the time of contract labor personnel in the plant.
2. A daily survey for the plant manager incorporating all data and calculations significant to this managerial level.

\* \* \* \* \*

## NEWS ITEMS

### Applications

#### Saturn V Tests System Uses PDP-5 Computers

NASA's Marshall Space Flight Center at Huntsville, Alabama, has installed three general-purpose Programmed Data Processor-5 computers.

The three computers and peripheral equipment form part of a ground-based testing complex for use in NASA's Saturn V program. Saturn V is a three-stage launching vehicle with a first-stage thrust of 7.5 million pounds. It will be the time booster for the first manned moon landing using the lunar-orbit-rendezvous method. The first flight is scheduled in 1966.

The three PDP-5 computers will function as central control elements in an on-line data acquisition system in the center's

Astrionics Laboratory. The system will test inertial components for the Saturn guidance system in a controlled laboratory environment.

The data acquisition and processing was formerly performed manually.

Each of the PDP-5s includes a 4096-word memory and an input-output tape teleprinter. Also included is a 200-card-per-minute reader, dual DEC tape system, analog-to-digital converter, logic circuit modules for peripheral equipment interfaces.

\* \* \* \* \*

#### Coast Guard Buys PDP-5 for Sea and Shore Duty

The Coast Guard has purchased a PDP-5 computer for use in reducing oceanographic data at sea and ashore.

The data is used principally to construct a Geostrophic Current Chart in order to predict the speed and course of icebergs drifting into the major shipping lanes near the Grand Banks. The Coast Guard performs this work for the International Ice Patrol.

A PDP-5 has earlier been tested for the work during the 1964 ice patrol cruises on board the Coast Guard oceanographic vessel Evergreen, when data was taken at nearly 500 oceanographic stations. Use of the computer shortened the calculation time from three hours per station by hand to 15 minutes by machine. It also made possible more complete processing while at sea, eliminating the previous hand calculating done ashore after the ship docked.

Calculations include determining average and difference temperatures of paired protected and unprotected thermometers, thermometric depth, anomaly of specific volume, oxygen content and saturation, temperature and salinity at standard depths, and dynamic height.

In addition to performing these assignments on the Evergreen, the PDP-5 will be used ashore in Washington following the end of the ice patrol season to process similar data gathered elsewhere by other Coast Guard vessels.

\* \* \* \* \*

#### Lederle Laboratories Using LINC Computer

Lederle Laboratories of American Cyanamid Company at Pearl River, N.Y., has purchased a LINC Computer for use in electrophysiological and neuropharmacological experimentation.

The Experimental Therapeutics Research Section of Lederle's Department of Experimental Pharmacology is using the LINC to analyze the effects of drugs upon responses electrically evoked from various segments of the central nervous system of mammals.

In the future, the computer is expected to serve in addition as a control element in these experiments.

The computer is currently used not only in an on-line mode to collect, treat, and store data about bioelectric potentials, but also in an off-line mode to subject the data to various mathematical and statistical procedures.

Programs are being written to perform similar experimental

procedures upon data derived from the responses of single units of the central nervous system to electrical stimulation. Computer control of the examination of the electrical correlates of several of the determinants of animal behaviour is in the planning stage.

\* \* \* \* \*

#### Brookhaven Using PDP-5 for Film-Scanning Work

Brookhaven National Laboratory at Upton, Long Island, N. Y., has purchased a PDP-5 computer for use on line by the Physics Department in a film-scanning application.

The photographs are taken as elementary particles interact in a bubble chamber. The computer records in digital form for later analysis a three-dimensional numerical description of selected particle tracks recorded by the photographs.

The track description is generated by shaft angle encoding equipment attached to manually operated photoelectric scanning machines.

Before using the PDP-5 for this work, the operators punched data from the machines into paper tape, and the tape was later taken to the computation center.

The PDP-5 is expected to eliminate the format and book-keeping errors that could lessen the usefulness of data prepared under the earlier method.

\* \* \* \* \*

#### Digital Building Systems for AIL Radiation Studies

Three analog-to-digital conversion systems for use in analyzing solar radiation have been ordered by Airborne Instruments Laboratory.

The systems will be used by AIL's Applied Electronics Department of Deer Park, New York, to convert analog energy received by radio telescopes from the sun into digital values for recording on incremental magnetic tape transports. The recorded data will later be reduced in a computation center. The goal of the project is to be able to predict the onset of solar radiation which could be harmful to astronauts.

Earlier, the information was presented to the operators on strip chart recordings. The operators examined the charts and used them to prepare data which could be read into the computer.

The new systems will speed up the process and eliminate format errors in the input preparation step. Included in each system will be a three-channel multiplexer, a special analog-to-digital converter, control logic for the converter and the tape transport, and a real time clock.

The data to be recorded on tape includes time, identification of channels exceeding threshold values in each scan, the scan interval, and a 12-bit number representing the strength of the received energy. Console switches and controls let the operator enter site and date information, vary the scanning interval in five steps from 1 to 30 seconds, and set the threshold value for each channel independently.

#### New York University's PDP-7 Computer for New Science Laboratory

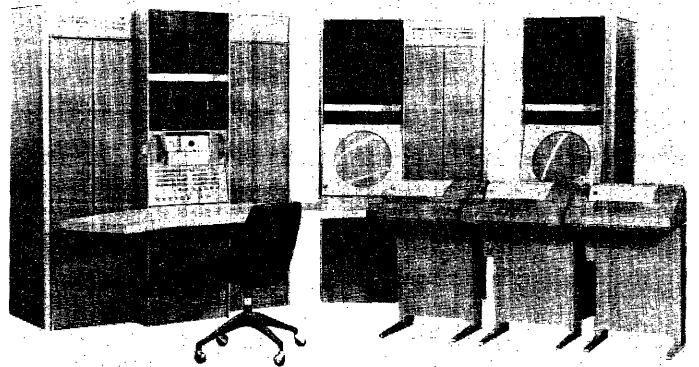

The PDP-7 computer and peripheral equipment pictured above was recently installed at New York University, Department of Industrial Engineering and Operations Research. The PDP-7 will act as the nucleus of a systems science laboratory where undergraduates and graduate students can experiment with computer applications and develop new engineering methodologies.

The new laboratory is an unprecedented facility and is expected to become a vehicle for dramatic changes in experimentation, course work, and research.

Undergraduates will experiment with known applications for computers and design experimental systems for new applications. Graduate students will gain in the laboratory the experience needed to develop new ways of solving engineering problems.

Peripheral equipment includes a precision incremental CRT display with a slave display and light pen; a data communication subsystem with two remote teleprinter keyboards; a 300-character/second paper tape reader; and a 63-character/second tape punch.

Other installations planning to use displays with the PDP-7 are:

Stanford University - Pulse Height Analysis

University of Delft, Germany - Control Engineering

Rensselaer Polytechnic Institute - On-line data acquisition, reduction and control in nuclear physics experiments

University of Oxford, England - On-line to Nuclear Structure Experiments

University of Cambridge, England - Display Control System

University of Pittsburgh - Controlling psychological experiments, computer-based instruction

University of Texas - Use in Accelerator Laboratory

# Programming

## MULTIPLE PRECISION RADIX DEFLATION

By: James Langley, Digital Equipment Corporation

Radix deflation may readily be extended to multiple precision arithmetic. As an example of this, consider the following six digit BCD number stored in two words.

$$D_5 16^5 + D_4 16^4 + D_3 16^3 + D_2 16^2 + D_1 16^1 + D_0 16^0$$

Applying single precision radix deflation (see Decuscope Vol. 4, No. 1) to each word in turn the following result is obtained.

$$\left[ (D_5 10^2 + D_4 10^1 + D_3 10^0) 16^3 \right] + \left[ D_2 10^2 + D_1 10^1 + D_0 10^0 \right]$$

where each bracket represents the contents of one word.

The radix  $16^3$  must now be deflated to  $10^3$ . A double precision two bit right shift of the most significant word only will deflate to 1024. The most significant word only must next be shifted left three and then four bits and each of these quantities subtracted from the least significant half of the previous result.

Double precision addition of the quantity on the right hand of the equation above yields the correct result.

\* \* \* \* \*

## GRAPHpad

By: Dave Brown and William Long, Digital Equipment Corporation

GRAPHpad is a special purpose program to demonstrate the capability of the 340 Display and the PDP-4 or PDP-7, and to provide the type of displays and controls one might need for a drafting program.

As the program stands now there are 8 permanent symbols and 64 alphanumeric characters available to the draftsman. These symbols, together with individually defined lines are the forms with which the draftsman may create a picture. Sample symbols are flip-flop, resistor, inverter, etc. Each permanent symbol is specified by increment and vector mode words located in the Permanent Symbol Table.

There are five modes of operation of the program: Symbols Mode, Line Mode, Alphabet Mode, Title Mode, and Erase Mode. Mode selection is by pointing the light pen at one of the five control characters, S L A T E, displayed at all times that the mode may be changed.

**Symbols Mode** - The program starts in Symbols Mode. In Symbols Mode, the permanent symbols are displayed along with the control characters S L A T E. The draftsman selects the desired symbols by pointing the light pen at the symbols displayed for selection, and positions the symbols on the screen by pointing the light pen at the desired position on the screen.

**Line Mode** - The draftsman selects either a horizontal-then-vertical or a vertical-then-horizontal pair of lines and positions them with the light pen. The length of either or both of the lines will adjust to follow the pen once the starting point has been fixed. There are no slant lines available in GRAPHpad to date.

**Alphabet Mode** - The operator may select any number of characters from those displayed and position them on the screen with the pen just as in Symbols Mode.

**Title Mode** - A title and frame appears around the picture as illustrated by the GRAPHpad brochure. Pointing the light pen at DEC in the title will cause the picture (only) to be punched on paper tape for off-line storage.

**Erase Mode** - The draftsman may erase any symbol with the light pen. A confirmation of this intention is required by the draftsman to prevent accidental erasures.

The organization of the data to be displayed as drawn figures is such that each drawn symbol is represented by only five words of PDP-4 memory in a Drawn Figures or Drawn Lines Table. The five-word set specifies the x and y coordinate of the symbols and the address of that symbol's representation in the permanent symbol table. Thus for a drawing of ten flip-flops, there is one flip-flop picture representation stored in the PDP-4 memory (Permanent Symbol Table) and ten five-word sets that point to that representation to be displayed at ten different locations on the screen.

A complete writeup, including a symbolic listing, and tapes are available and may be obtained by contacting either DECUS or the Digital Program Library.

Other 340 Display programs presently available are: "Floating Diamond," "6 Closed Figures" and "Lotsa Litul Pichas Onna Four."



## Literature Available

### PDP-4 FORTRAN Program Description, Digital 4-40-5

The book is divided into three sections: FORTRAN Manual, Users Manual and FORTRAN Summary Description. The FORTRAN Manual is for the less experienced programmer and contains many programming examples as well as introductory material. The Users' Manual details standard operating procedures for the PDP-4 FORTRAN system. Diagnostics and Error Messages are included as appendixes to this book. FORTRAN Summary Description describes the language used by the PDP-4 FORTRAN Compiler for those familiar with existing FORTRAN dialects. Contact the Digital Program Library for copies of this publication.

### MACRO-6 Assembly Language, DEC-6-0-TP-MAC-LM-FP-ACT-1

The book describes the assembly language for the PDP-6 in the first three chapters. The rest of the book deals with miscellaneous related topics.

### PDP-6 FORTRAN II Language, DEC-6-0-TP-FII-LM-PRE00

This manual describes the FORTRAN II language and explains its use with the PDP-6.

### PAL II Addenda

This addenda briefly describes the revision in the operating characteristics of PAL. The entire manual is being rewritten and will be distributed shortly.

### 1964 DECUS PROCEEDINGS

Papers presented at the 1964 DECUS Spring and Annual Meetings are presently being published in the 1964 DECUS PROCEEDINGS. Copies of this proceedings will be sent to all PDP Installation Delegates within the next few weeks. Others may obtain copies by contacting the DECUS Office.

\* \* \* \* \*

## COMPUTER OPTIONS

### 570 MAGNETIC TAPE TRANSPORT

The Type 570 is a digital magnetic tape transport designed for use with any Programmed Data Processor. With PDPs 1, 4, 5, 6, 7, and 8 the transport connects through a Type 521 Interface and a Type 57A Control. With PDP-6 a 521 Interface, 516 Control, and 136 Data Control are used.

Included with the 570 is a multiplex interface which permits time-shared use of the transport by two tape controls on the same or different computers. With this feature the user can establish a tape pool of given capacity with fewer transports

than would be needed in a non-sharing system. In addition, one tape control under program control may use a number of transports for split or merge operations, returning the transports to the pool only when the split or merge is complete. A third application of the interface is in the exchange of information between computers via tape.

The 570 records at densities of 200, 556, and 800 characters per inch at speeds of 75 or 112.5 inches per second. Maximum transfer rate is 90,000 characters per second. Electro-pneumatic drive keeps tape stress far below that of a pinch roller drives, with consequent reduction of tape distortion and wear. At the same time, total acceleration time to constant tape speed is equal to that of pinch roller drives. Other features include: straight-through threading, automatic rewind-brake-stop sequence, and a rewind time of 90 seconds for 2400 feet.

**Electro-Pneumatic Drive:** The 570 Transport mechanism is an electro-pneumatic one of new design. Tape is moved by contrarotating, porous capstans, against which the tape is forced by air pressure from clamps over the capstans. Motion is stopped when the tape is lifted off the capstan by back pressure from within the capstan, and the tape is forced against a brake, also by air pressure.

This technique offers advantages over vacuum-controlled systems. First, the pressure differential that forces the tape against the capstan is not limited to one atmosphere; thus faster tape acceleration can be achieved. Second, the complicated switching necessary to reverse pressures from above atmospheric to below atmospheric is eliminated. Third, the momentary abrasion to which tape is subjected as it is pulled away from the vacuum on a slotted capstan is avoided.

Compared to pinch roller drives, the 570 capstan subjects the tape to one-tenth the tensile stress because of air cushioning during acceleration, yet a stabilized read-write speed is reached just as soon (4 milliseconds maximum after the command signal). Indentation of the tape caused by impacts of pinch rollers is eliminated.

\* \* \* \* \*

### TYPE 24 SERIAL DRUM

The Type 24 Serial Drum system, a standard option for Programmed Data Processors PDP-1, PDP-4, and PDP-7, is available in three storage sizes: 32,768, 65,536 and 131,072 19-bit words. Information is stored and transferred in blocks of 256 18-bit words. Each drum word contains 18 information bits and 1 parity bit. Average access time is 8.65 milliseconds. A computer word is transferred in about 67.2 microseconds; a block transfer is completed in 17.3 milliseconds. Computation continues during block transfers.

Two instructions cause the transfer of a 256-word block. The first specifies the core memory location of the block and the direction of transfer (drum to core or core to drum). The second instruction specifies the block or track number and initiates the transfer. Transfer of each word is under control of the computer data interrupt control and is interleaved with the running program.

# DECUS PROGRAM LIBRARY

## PDP-1 LIBRARY CATALOG ADDITIONS

### DECUS NO. 79

Title: Extended Memory Punch and Loader Routines (EXPCH1 and EXPCH0)

Author: William E. Fletcher, BBN-Cambridge

Purpose: To facilitate punching and loading binary information from any memory bank in the PDP-1.

Type: Utility

Programming Language: DECAL-BBN

Storage Used: 7500-7707 in either Core 0 or Core 1

Comments: Punch program as presently set up can reside in either Core 0 or Core 1. When tape is read in, a loader is automatically punched out. Any number of blocks in any memory bank can then be punched out under typewriter control. When resulting tape is read back into the computer, all of the information will be loaded into proper locations regardless of the setting of the test address switches.

### DECUS NO. 80

Title: DEXTER, a magnetic tape executive routine.

Author: Robert D. Keim, Wolf Research and Development Corporation developed under Air Force Contract AF19(628)-1614 at AFCRL, CRBI.

Purpose: To provide an efficient method of loading programs from magnetic tape under on-line operator control.

Hardware: PDP-1 (8k), Type 52 Magnetic Tape Control Type 50 Tape Transport (two required for editor).

Language: AMP (can be converted to DECAL or MACRO easily).

Description: DEXTER is an executive routine designed to facilitate the operation of a PDP-1 data processing system during experimental runs. It affords the experimenter full communication with the system from the console. DEXTER requires an 8K PDP-1 with a Type 52 Magnetic Tape Control. The software consists of an executive routine and a maintenance routine. Other programs are written in a DEXTER COMPATIBLE FORMAT and stored on the executive magnetic tape. At run time DEXTER is loaded into the computer which is equipped with a magnetic tape on which are stored the necessary routines. The order in which these are loaded and executed by the executive program may be specified either by the experimenter from the on-line typewriter or by the program itself as a result of computation, etc. This gives the desired flexibility without sacrificing speed or efficiency.

When a program is called, the executive routine restores itself, rewinds the tape, and searches for the correct block. If the program is not found, control is returned to the experimenter at the keyboard. If it finds the program, DEXTER loads the routine, over itself if necessary, and transfers control to the program. The program must return control to DEXTER when it is finished so that other programs can be called.

Other DEXTER features are: minimum programming restrictions, minimum storage limitations (self-restoring), full debugging features, and a comprehensive editing program for preparing the executive tape.

\* \* \* \* \*

## PDP-5 LIBRARY CATALOG ADDITIONS

### DECUS NO. 5/8-17

Title: Type 250 Drum Transfer Routine for use on PDP-5/8

Author: G. Arthur Mac Ilroy, the Foxboro Company, Natick

Purpose: Transfer data from drum to core (Read) or core to drum (Write) via ASR 33 Keyboard control.

## MEETINGS

### CALL FOR PAPERS

The American Federation of Information Processing Societies has issued a call for papers for the Fall Joint Computer Conference which will be held this year at Las Vegas, Nevada, November 30 - December 2nd. The deadline for papers is June 15, 1965. Send one complete draft copy, together with a 150-word abstract to:

Mr. Robert Gray, Secretary  
Program Committee 1965 FJCC  
Post Office Box 49  
Santa Monica, California 90406

\* \* \* \* \*

### FASEB MEETING

The Federation of American Societies for Experimental Biology (FASEB) will hold its meeting at Convention Hall, Atlantic City, New Jersey on April 10-14.

At this meeting, Digital Equipment Corporation will conduct simulated biomedical laboratory demonstrations using the Laboratory Instrument Computer (LINC). Programs will be used which demonstrate averaging of physiological signals, and plotting of histograms and ECG data.

The PDP-8 and the Module Laboratory Trainer will also be demonstrated.

# NEW DECUS MEMBERS

## PDP-4 DELEGATES

David Vander Yacht  
University of Michigan  
Center for Research on Language  
Ann Arbor, Michigan

## PDP-5 DELEGATES

J. I. Meltzer will replace Mrs. Ruth Kelly  
as delegate from Bell Telephone Laboratories,  
New York, New York

Jack P. Richards  
Westinghouse Astrofuel Facility  
Cheswick, Pennsylvania

Lance L. Strayer  
Boeing-Huntsville Simulation Center  
Huntsville, Alabama

E. E. Wuschke  
Whiteshell Nuclear Research Establishment  
Pinawa, Manitoba

Jacques Moureton  
Groupe De Recherches Ionospheriques  
Seine, France

Dr. Barry Barish  
Synchrotron Laboratory  
California Institute of Technology  
Pasadena, California

## PDP-7 DELEGATES

B. E. F. Macefield  
Nuclear Physics Laboratory  
University of Oxford  
Oxford, England

Dr. Ronald G. Ragsdale  
Learning Research and Development Center  
University of Pittsburgh  
Pittsburgh, Pennsylvania

## PDP-8 DELEGATES

A. Seidman and G. W. Hutchinson  
University of Southampton  
Southampton, England

J. S. Fraser  
Chalk River Nuclear Laboratories  
Chalk River, Ontario

## INDIVIDUAL MEMBERS

Bernard I. Savage  
1340 Commonwealth Avenue  
Boston, Massachusetts

N. S. Wells  
Atomic Energy of Canada Ltd.  
Chalk River, Ontario

Claude Eon  
Groupe De Recherches Ionospheriques  
Seine, France

Robert E. Werner  
Lawrence Radiation Laboratory  
Livermore, California

John W. McClure  
Lawrence Radiation Laboratory  
Livermore, California

Willard A. Bryant  
Rensselaer Polytechnic Institute  
Troy, New York

Edward D. Gilbert  
Bolt Beranek and Newman, Inc.  
Cambridge, Massachusetts

Frank S. Greatorex, Jr.  
Charles W. Adams Associates  
Bedford, Massachusetts

Harold Levy  
Scientific Engineering Institute  
Waltham, Massachusetts

Daniel J. Gold,  
Shlemo Lampert and  
E. S. Fine  
New York University  
Bronx, New York

Dr. R. H. Goodman  
555 Booth Street  
Ottawa, Ontario

Gerald P. Calame  
Rensselaer Polytechnic Institute  
Troy, New York





11:15 USE OF A PDP-5 FOR THE COLLECTION OF MOSSBAUER EXPERIMENTAL DATA  
R. H. Goodman, Department of Mines and Technical Surveys (Canada)  
J. E. Richardson, Digital Equipment of Canada

Abstract The nature of Mossbauer experiments and their application in solid state physics will be described briefly. The two types of experimental situations, constant velocity and constant acceleration, and the relative merits of each will be presented. An outline of the conversion of the experimental data to digital form and the use of the PDP-5 as a Mossbauer data acquisition device will be discussed. Typical sets of experimental spectra indicate the overall performance of the system.

11:45 LUNCH - HARVARD FACULTY CLUB

Luncheon Speaker - Dr. James Oliver, Dean of the Graduate School, University of Southwestern Louisiana

1:30 p.m. A HIGH SPEED MAN-COMPUTER COMMUNICATION SYSTEM  
Earl H. Brazeal, Jr. and Taylor L. Booth, University of Connecticut

Abstract This paper describes a high speed, man-computer communication system which is presently being employed on a research program at the University of Connecticut. This program is aimed at determining how best to integrate a human operator and a small computer (PDP-5) in a signal processing and detection system.

The man-computer communication system consists of an electrostatically deflected cathode ray tube, a light pen tracking unit, and a display control unit. The I/O facilities of the PDP-5 are used to full advantage to control the basic operation of the system. This paper describes the peripheral equipment used and its unique operational features. The research applications are also discussed.

2:00 PDP-5 PROJECTS AT LAWRENCE RADIATION LABORATORY  
Sypko Andreae, Lawrence Radiation Laboratory, Berkeley

Abstract PDP-5s at LRL are now being used in several different applications, the main one being data acquisition and limited data analysis of experimental data. Those PDP-5s work on-line with the experiments in the accelerators. Examples of instruments and interfacing used in these experiments are given. Progress in the development of simple techniques for data transmission from the PDP-5 to the computer center and back are discussed. The main configurations of two other PDP-5 systems is explained. One is a PDP-5 with many I/O devices working on-line to experiments in the 88 cyclotron, and another is a PDP-5 with a 630 system which will be used as a message switching center during laboratory experiments in the study of human behavior.

2:30 COMPUTER SYSTEMS FOR RECORDING, RETRIEVAL AND PUBLICATION OF INFORMATION  
Richard J. McQuillin and Joseph T. Lundy, Inforonics, Inc.

Abstract The authors give a comparative description of the various types of typesetting machinery; hot-metal, photo-composition, and cold-type composition. The areas of applicability of each of these methods can overlap, but publishing applications are described where one type of machine is more suitable than others.

Justification and hyphenation are fundamental problems of automated typesetting. The standards of measurement used by the printing industry must presently be incorporated into the automatic system. In addition, the problems of complex typography, such as mathematical formulae, and the problems of page make-up are discussed.

Typesetting machines are viewed from the aspect of a computer-based installation. This

paper discusses solutions to various problems arising in preparation of text in computer readable form, in methods of editing and correcting this data, and the flow of information into typeset material and/or retrievable machine data files.

3:00 SAVAGE SYSTEM: A MONITOR SYSTEM FOR THE PDP-4/7  
Bernard I. Savage, Consultant, Harvard University

Abstract The Savage System is a monitor system which is fully compatible with all previous DEC software for the PDP-4. The System requires one microtape unit and occupies 2K of memory. It is controlled by type-in commands that permit a user to load any program from microtape, dump data onto microtape, restore to memory previously dumped data, write data into memory, or print data from memory. The Monitor initializes, bootstraps, and housekeeps itself. It also writes programs onto microtape for later loading. It includes a teletype I/O package and a microtape I/O package which respond to one-instruction macro-calls, and thereby perform all necessary teletype and/or microtape I/O programming functions.

Copyright 1964, Bernard I. Savage. All rights reserved.

3:30 COFFEE

3:45 TOUR AND DEMONSTRATIONS - CENTER FOR COGNITIVE STUDIES  
(William James Hall)

4:00 BUSINESS MEETING- DECUS Delegates and Executive Board

5:00 - 6:30 SOCIAL HOUR - First Floor of William James Hall

## FRIDAY - MAY 21

8:30 a.m. - 8:45 a.m. SECOND DAY REGISTRATION AND COFFEE  
(First Floor of William James Hall)

8:55 OPENING OF SECOND DAY - John T. Gilmore, Jr.  
DECUS Meetings Chairman

9:00 PDP-5/PDP-1 ON-LINE DATA COLLECTION AND EDITING SYSTEM  
P. Larrea, Princeton-Pennsylvania Accelerator

Abstract On this system, a 12K PDP-5 accepts data from up to 10 film measuring machines. As it comes in, data is edited for a number of possible errors, e.g. label duplication, correct sequence of measurements not being followed, machine or interface malfunctions, etc. All correct data is collected in a table from which, at specific times (end of measuring a track or a point in all its views), it goes to a 16K PDP-1 which will perform a simple spacial reconstruction to determine whether certain criteria as to location of measurements (X and Y coordinates) has been met. When all checks have been made and event is complete, it will be written on magnetic tape for further processing.

9:30 A VERSION OF LISP FOR THE PDP-6  
William A. Martin, M.I.T. Project MAC

Abstract LISP input-output has been extended to include a dataphone and the Type 640 Oscilloscope with character generator and light pen. A macro language for describing pictures has been embedded in LISP. This system makes possible the coupling of pictorial displays with problems conveniently programmed in LISP, as well as the study of recursive pictures. The choice of concepts for a picture language and trade-offs involved in its implementation are discussed.

10:00 A REPORT ON THE IMPLEMENTATION OF THE KEYDATA SYSTEM  
Charles W. Adams, C. W. Adams Associates, Inc.

Abstract The KEYDATA System utilizes a PDP-6 (with 48K core, a million - word drum, a 33-million-character disc file, and a full-duplex Type 630 interface) as the control facility for on-line, real-time data processing services offered to business and engineering users through KEYDATA Stations (Teletypewriters) located on their premises. Both packaged services, such as the preparation of invoices and the entry and correction of FORTRAN programs and data, operate through the KOP-3 executive routine. To prepare invoices, for example, the operator keys the quantity and stock number and the computer provides the description, prices, extensions, etc. on an invoice form in the users' teletypewriter as well as inventory control and credit checking on-line, and related statistical and accounting reports off-line.

In the KOP-3 system, the drum serves as the primary storage for all data and programs (except KOP-3), and also acts as the file directory, output buffer, and repository for the most active file records. Working storage is provided through automatic allocation of core memory in 32-word pages.

10:30 TOURS AND DEMONSTRATIONS - ADAMS ASSOCIATES KEYDATA FACILITIES AND PROJECT MAC (Both located at Technology Square in Cambridge. Bus service will be provided.)

12:00 LUNCH - HARVARD FACULTY CLUB  
Sound-off Session (Problems regarding software and hardware will be discussed in a question-and-answer session.)

2:00pm A CHALK RIVER PDP-5 PULSE-HEIGHT ANALYZER  
D. C. Santry, Chalk River Nuclear Laboratories

Abstract Hardware has been added to a PDP-5 computer at Chalk River which enables it to operate simultaneously as two multi-channel pulse-height analyzers. Data obtained from scintillation spectrometers and semiconductor detectors are analyzed in an analogue-to-digital converter, and the pulse-height spectra obtained are stored in the computer's memory. Programming is used to obtain complete data reduction, i.e., process the stored data by doing background subtraction, spectrum stripping, integrations on any portions of the spectra and corrections for radioactive growth and decay. External equipment such as timers, automatic sample changers, and choice of detector are also under program control.

Operating experience gained with this integrated system will be discussed.

2:30 A DESCRIPTION OF THE PEPR SYSTEM  
David Friesen, Laboratory for Nuclear Science, M.I.T.

Abstract A system called PEPR (for Precision Encoding and Pattern Recognition) is being constructed at the Laboratory for Nuclear Science of M.I.T. The system is designed to automatically scan and measure photographs of bubble chamber "events." The PEPR system consists of a special purpose digital-analog film scanning device capable of high precision measurements, connected on-line to a PDP-1 computer. The scanning of film is directed by programs running in the PDP-1. A general description of the scanning hardware is given, and the current state of program development is described.

3:00 DEXTER - THE DX-1 EXPERIMENTERS TAPE EXECUTIVE ROUTINE  
Jerome Cohn, Wolf Research and Development Corporation

Abstract DEXTER is an executive routine designed to facilitate the operation of the DX-1 dynamic data processing system during experimental runs. It affords the experimenter full communication with the system from the console of one processor while maintaining the advantages of dual computer processing.

The software for DEXTER consists of a two-part executive routine and several maintenance routines. Other programs are written in a DEXTER COMPATIBLE FORMAT and stored on the executive magnetic tape. At run time, DEXTER is loaded into two computers which are connected through an information exchange, a one-word communication link. Each processor is equipped with a magnetic tape on which are stored the necessary routines. The order in which these are loaded and executed by the executive program may be specified either by the experimenter from the on-line typewriter, or by the program itself as a result of computation, etc. This gives the desired flexibility without sacrificing speed or efficiency. When a program is called, the executive routine restores itself and searches for the correct block. If the program is not found, control is returned to the experimenter at the keyboard. If it finds the program, DEXTER loads the routine, over itself if necessary, repositions the tape and transfers control to the program. The program must return control to DEXTER when it is finished so that other programs can be called.

Other DEXTER features are: minimum programming restrictions, minimum storage limitations (self-restoring), full debugging features, and comprehensive editing programs for preparing the executive tape. A basic version of DEXTER for a minimum PDP-1 is available and will be described.

3:30 COFFEE

3:45 THE USE OF A SMALL COMPUTER WITH REAL TIME TECHNIQUES FOR OCEANOGRAPHIC DATA ACQUISITION, IMMEDIATE ANALYSIS, AND PRESENTATION  
Robert M. O'Hagan, Digital Equipment Corporation

Abstract A compact, high-speed digital computer has been programmed to immediately analyze and evaluate data gathered from in situ data collecting instruments. This system will be described and its output presented.

This computer may be located either aboard an oceanographic vessel or at a land-based station. In the former case, the oceanographer can change the sampling depth intervals to obtain the most significant incremental changes in temperature, salinity Sigma-T, and sound velocity all of which have been computed from primary data. The computer also obtains and stores data at internationally accepted standard depths.

In the latter case, where the computer is located at a land station, the design of a telemetry link is discussed whereby data from buoy systems are handled. In this manner, the compact computer becomes a data monitoring and buffering device between the sensors and data storage as well as a tool to make possible immediate decisions.

The computer is programmed to generate oscilloscope displays of the raw data as well as the computed data as it is being collected, thus, it further facilitates the oceanographers evaluation of the ocean environment.

4:15 To Be Announced

ATTENTION SYMPOSIUM ATTENDEES

Maps of the Harvard University area and a list of hotels and their accommodations have been sent to DECUS delegates and members located outside the state of Massachusetts. If you are planning to attend the DECUS Spring Symposium and are not in contact with a DECUS delegate, please contact Mrs. Angela Cossette, DECUS, Maynard, Mass. 01754 for the information mentioned above.

Luncheons have been arranged for both days at the Harvard Faculty Club. Thursday's menu will be Braised Beef and Friday's will be Seafood Newburg. The registration fee, including the cost of both meals, is \$5.00. Persons not planning to attend the luncheons may register for \$1.00. Payment of the registration fee may be made at registration time on May 20th.

\*\*\*\*\*

DECUSCOPE is published monthly for Digital Equipment Computer Users Society (DECUS). Articles for publication should be sent to DECUS, Digital Equipment Corporation, Maynard, Massachusetts 01754.

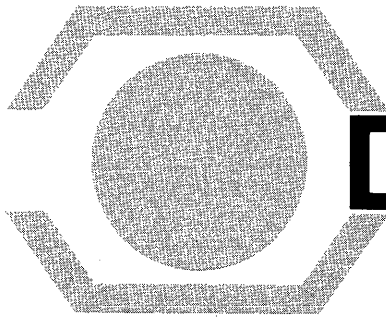

# DECUSCOPE

DIGITAL EQUIPMENT COMPUTER USERS SOCIETY

MAYNARD, MASSACHUSETTS / TEL. 897-8821 / TWX 710 347-0212

MAY 1965  
Vol. 4 No. 5

## PDP-5 AIDS IN MEDICAL RESEARCH AT UNIVERSITY OF MARYLAND

Sandra M. Morse  
University of Maryland  
Department of Physiology

The PDP-5 which Dr. Paul D. Coleman has recently added to his laboratory in the Department of Physiology at the University of Maryland will be used in several areas of research. The basic computer has been interfaced to operate several other devices.

### Auditory Physiology

In a study being done in auditory physiology, the PDP-5 delivers a stimulus pulse to earphones producing either clicks or pure tone pulses to the ears of a cat located in a shielded soundproof room. The stimulus parameters currently under study are: interaural time delays and interaural intensity ratios. The time delays are controlled by the program, while the intensity ratios are set by a computer-controlled stepping switch.

The stimulus parameters are randomly delivered with one pulse for each variable before the next pulse for any variable is delivered. This is continued until there have been N stimulus pulses for each of 20-35 variables. The evoked response is recorded from either a single microelectrode or from four gross electrodes placed in the auditory cortex. The response input to the PDP-5 is via an A-D converter. The data is recorded in one of two forms depending upon the type of experiment being conducted. When recording with microelectrodes, the number of responses of a single neuron to a set number of stimulus pulses are summed in post stimulus time and interspike interval histograms. The data is then processed for latency, frequency and probability of responses as a function of the stimulus variables.

Gross responses to stimuli are recorded with four electrodes connected into the A-D converter through a four-channel multiplexer. The time-locked responses to the stimuli are averaged using the same principle as a computer of average transients. After a preset number of stimuli, the summed responses are displayed on an oscilloscope allowing for critical points to be picked out by a DEC light pen. Means and standard deviations of these points are displayed as functions of the variables. The data is printed out and the display photographed.

### Dendritic Fields of Neurons in the Brain

A second project for which the PDP-5 will be used is to study the dendritic fields of neurons in the brain. The brains from

rats of two strains, which have been shown to be genetically different in terms of maze-learning ability, are being studied to determine the possibility of structural differences existing in the neurons of specific areas. The brains are sectioned and mounted on glass slides for microscopic examination.

A microscope is being equipped with a specially designed motor-driven stage. Stepping motors controlled by the computer will move the stage in half-micron steps in three axes. A photomultiplier output is connected to the computer through the A-D converter; a diaphragm is used to narrow the field examined by the photomultiplier.

The cell body of a neuron meeting certain specifications will be manually centered under the photocell. Under the control of the computer, the neuron with its complete dendritic field is tracked. As it is being tracked, it is being drawn out by an X-Y plotter which is part of the interface. In addition to the drawing, certain measures will be made internally by the computer. These measures will include information concerning the total lengths of the dendrites, the number of branchings of new dendrites off the ones originating from the cell body, the numbers and lengths of various orders of dendrites (an order being defined as the segments between the cell body and a branching point or between two branching points). In addition to the particulars of single neurons, more generalized measures will be taken by linear and angular scans of selected areas of the sections. This enables comparisons of areas as well as cell for cell.

In the past this work was all done by hand, taking one to two days to draw one of the more complex neurons and a few hours for taking the various measurements. With the motorized microscope operated by the PDP-5, it is predicted that one neuron can be completely processed in 10 minutes.

### Diagnosis

The PDP-5 will also be used to demonstrate computer diagnosis of neurological lesions to medical students. The students type in the various symptoms observed in a set of demonstration cases, and the PDP-5 types out the diagnosis.

# SYSTEMS SCIENCE LABORATORY

## AT NYU TO USE PDP-7

Mark S. Mayzner, Sanford Adler,  
Norman N. Barish, New York University

This note is intended to describe the Systems Science Laboratory (SSL) recently established by the Department of Industrial Engineering and Operations Research at New York University. The basic configuration of the Laboratory consists of a PDP-7 computer, a modified CRT display Type 340 (which drives up to four slave displays), a slave display Type 343, a character mode, two light pens, a data communication system consisting of a basic control Type 634A-5, 630-12, a send/receive group with 2-4706 and 2-4707 Type 732C-5, and two 33ASR teletype machines Type 635E. In addition, the SSL has closed circuit TV cameras and TV monitors. The TV cameras are focused on the computer-generated displays, which allows the information on the computer-generated displays to be presented at each of the TV monitor positions, thus greatly expanding the display capability of the two CRT consoles.

The SSL was made possible by a \$50,900 National Science Foundation grant and matching funds from the University, and is the largest of 1,016 grants for instructional scientific equipment made recently to 565 American institutions. The SSL will serve two major functions within the Department.

First, the SSL provides a unique instructional tool in a large number of undergraduate and graduate courses, including the following: Economic Analysis I - Engineering, Economic Analysis II - Managerial, Industrial Management, Operations Research Project, Methods Engineering I - Process Analysis, Methods Engineering II - Work Measurement, Human Factors in Engineering Design, Research Methods in Human Factors, and Information Processing in Man. The basic rationale for such a Laboratory is found in the interdisciplinary nature of industrial engineering and operations research educational objectives as set forth in the Department's curriculum, which provides the student with a strong background in five major areas: namely, engineering, mathematics, physical science, economics, and psychology. Thus, the SSL serves as a natural focus and point of interaction for the various disciplines of the Department and provides an instructional climate that realistically reflects modern engineering and scientific technological developments.

Second, the SSL will serve as a powerful research vehicle and a number of research projects employing the SSL are in various stages of development and implementation. For example, the computer-generated display capability will be employed extensively in studies on information processing in man including experiments on short-term information storage and retrieval in man, visual search and scanning problems, simultaneous and sequential perceptual processing problems, decision-making problems, and small group and system research problems. Plans also are being formulated to greatly expand out current capability with additional core memory, DECtape units, and drum storage; and research programs will then be carried out involving economic and market simulations, business and industrial gaming, etc., which require greater memory capacity than is available with our current PDP-7 system.

# LETTERS TO THE EDITOR

Dear Sir:

"I would like to inform you of my current work, as you may wish to make note of it in the May issue of DECUSCOPE. Since I was familiar with DDT for the PDP-1, I considered it important to have a comparable debugger for our PDP-5.

Please find enclosed a copy of the DDT-5-2 Memo, which describes the debugger (to be used with Pal II programs) which we have been successfully using on our machine."

Michael S. Wolfberg  
University of Pennsylvania

Below is the abstract for the program mentioned in the above letter. The complete program will be available thru DECUS shortly.

### DDT-5-2 Octal-Symbolic Debugging Program

DDT-5-2 is an octal-symbolic debugging program for the PDP-5 which occupies locations 5600 through 7677. It is able to merge a symbol table punched by PAL II and stores symbols, 4 locations per symbol, from 5577 down towards 0000. The mnemonics for the eight basic instructions and various OPR and IOT group instructions are initially defined (see DEC-5-1-S Attachment II, p. 21), and the highest available location for the user is initially 5373.

From the teletype, the user can symbolically examine and modify the contents of any memory location. DDT-5 allows the user to punch a corrected program in BIN format.

DDT-5 has a breakpoint facility to help the user run sections of his program. When this facility is used, the debugger also uses location 0005.

This program has nearly all the features of DDT for the PDP-1. The meaning of the control characters of ODT (DEC-5-5-S) are the same in DDT-5.

\*\*\*\*\*

Dear Sir:

"In the last DECUSCOPE I read that the University of Delft, Germany had purchased a PDP-7. Fine! But as a graduate from that university, I must insist that the university is pure Dutch. May I suggest a correction in DECUSCOPE?"

Sypko Andrae  
LRL, Berkeley

Editor's Reply:

We hereby stand corrected! The University of Delft is located in The Netherlands.

DECUSCOPE is published monthly for Digital Equipment Computer Users Society (DECUS).

Material for DECUSCOPE should reach the editor before the 7th day of the current month for publication in that issue.

DECUSCOPE is published in Maynard, Massachusetts.  
Editor: Angela Cossette, Digital Equipment Corporation  
Publications Chairman: Joseph Lundy, Inforonics, Inc.  
Present Circulation: 1000 copies per month

## NEWS ITEMS

### Applications

#### UNIVERSITY OF BONN TO USE PDP-6 IN PHYSICS DEPT.

The Physics Department of the University of Bonn will be using a PDP-6 computer for use in processing physics research data. The PDP-6 is scheduled to arrive at the University sometime in June.

The computer will be used mainly to improve the automation of track chamber measurements. The data is contained in photographs of subatomic particle paths taken in a bubble chamber. As a first step, the PDP-7 will be connected to two semiautomatic measuring projectors, which determine the coordinates of particle tracks. The role of the PDP-6 is on-line monitoring of the measuring projectors, thus increasing the measuring speed by a factor of two.

In a later step, the computer will control an electro-optical device (PEPR), now being developed at Massachusetts Institute of Technology, Cambridge, which will be copied by the university. This device scans the photographs and classifies the information automatically. The operating speed is expected to be more than 100 times as fast as rates achieved by earlier semiautomatic or manual scanning methods.

Each photograph of the many thousands taken during a typical experiment will be examined to record in the system in digital form such information as track location, origin, length, slope, and vertices. The scanning is performed with a short line segment generated by a precision cathode ray display.

Under computer control, the line is swept repeatedly over the film, and a photomultiplier tube detects the tracks, and sends identifying information to the computer.

The role of the PDP-6 is to generate the scan pattern commands, store coordinate information about the tracks, and single out those which are of interest to the experimenters.

The PDP-6 at the university will consist of arithmetic processor, console teleprinter, 32,786-word memory, data channel, 2 dual DECTape transports and control, 2 magnetic tape transports and control, incremental CRT display and light pen, card reader and control, line printer and control, and a data communication subsystem to include three remote teleprinters.

\* \* \* \* \*

#### PDP-7s TO BE USED IN SEISMIC STUDY

Three general-purpose PDP-7 computers will be used by M.I.T. Lincoln Laboratory's Division 6 for a real-time seismic data processing application. Two will be used in the field in connection with a large seismic array. The third will remain at the laboratory for checkout and program development uses.

The laboratory conducts research in selected areas of advanced electronics, with responsibility for applications to problems of national defense and space exploration.

Each computer will include 8192 words of core memory, an extended arithmetic element, a data interrupt multiplexer, automatic magnetic tape control, and two tape transports.

#### AMRA REACTOR FACILITY USING PDP MULTIANALYZER

Scientists from Picatinny Arsenal working on the Nuclear Reactor Facility at the Army Materials Research Agency (AMRA), Watertown, Mass., are using a PDP Multianalyzer to time share between time-of-flight studies and the control of a neutron diffractometer used in crystal structure studies.

In the time-of-flight studies, neutrons derived from the reactor and scattered by a given sample are timed as they travel along a known distance to determine their velocity distribution and therefore, their energy distribution after scattering. This knowledge enables the experimenter to gain an insight into the dynamics of molecular motions in the samples under study.

The role of the Multianalyzer in this work is to accept, store, normalize, and present the time-of-flight data. The PDP-5 computer, on which the system is based, performs the storage, normalizing, and display generating portions of the task. Four independent scalars generate the timing information in separate channels. Each scalar can be read on the fly, that is without stopping the scalar as it counts in real time.

This operating mode permits the processing of several events during each run-down of the timer, and it reduces the time required to record a useful amount of data. It is more efficient in terms of machine time than system which must halt a scalar to read it, and it eliminates the cumbersome correction steps required when the scalar is halted for reading.

The object of the crystallographic studies is to determine the arrangement of atoms in a crystalline lattice and their exact relative position in this lattice. Thermal neutrons from the reactor impinge in the sample, and the intensity of the neutron beam scattered in various directions from the crystal is then measured. The computer-based Multianalyzer makes the investigation more efficient by performing many routine functions during the experiment. It also prevents any waste of time in data taking by pre-analyzing the data on line and then setting the relevant elements in the Multianalyzer for an actual data taking.

\* \* \* \* \*

#### PROGRAMMING NOTE ON ANALOG TO DIGITAL CONVERSION

The Riemann integral and the Lebesgue integration giving the density distribution function are in a sense equivalent in that they contain, when taken over the same interval, identical information concerning the statistics of a function.\*

This fact indicates that Lebesgue integration should be used to recover signal statistics when an analog signal is quantized to determine its statistics. Obvious programming advantages result particularly with respect to storage required.

\*See many articles by the late Norbert Wiener.

James Langley  
Digital Equipment Corporation



## Literature Available

### FROM DECUS

Abstracts of programs available for the PDP-1, PDP-4/7 and PDP-5/8.

LINC Test Programs to aid in the test, check-out, and maintenance of the LINC are now available. These programs consist of functional tests for about half of the order code of the LINC. Functional tests are written without regard to the logic of the computer, but are taken entirely from the written description of the instructions. As such, they represent a confidence check of the LINC. They offer no real diagnostic information, but only indicate a failure has occurred.

Reprints: "Data Processing at Sea" by Robert M. O'Hagan reprinted from *Geo Marine Technology*, Volume 1, No. 2.

### FROM THE DIGITAL PROGRAM LIBRARY

"Application Note 701-PDP-7 Gray Code Conversion"

This program compares adjacent bits in the Gray word. When they are equal, the corresponding normal bit is set to 0. When they are different, the corresponding normal bit is set to 1.

"PDP-8 Abstracts of Programs"

A short description of each program currently available for the PDP-8 or -5.

"Octal Memory Dump, Digital-8-6-U-Sym"

This is a description of the dump program routine for use on the PDP-8 or -5. This routine reads the console switches twice to obtain the upper and lower limits of an area of memory, then types on the Teletype an absolute address plus the octal contents of the first four words specified and repeats this until the block is exhausted. At this time the user may repeat the operation.

"PDP-8 DECTape Programming Manual, Digital-8-27-U"

This manual is a description of the DECTape software which has been developed for the PDP-8 under three categories:

1. Subroutines which the programmer may easily incorporate into a program for data storage, logging, data acquisition, data buffering, etc.
2. A library calling system for storing named programs on DECTape and calling them with a minimal size loader.
3. Programs for performing tapes controlled by the content of the switch register to write the timing and mark channels, to write block formats, to exercise the tape and check for errors, and to provide ease of maintenance.

"DDT-8 Programming Manual, Digital-8-4-S"

This manual describes the debugging system for the PDP-8 or PDP-5.

## COMPUTER OPTIONS

### DECTape DUAL TRANSPORT 555

The Type 555 Dual DECTape Transport consists of two logically independent tape drives capable of handling 3.5-inch reels of 0.75-inch magnetic tape. Bits are recorded at a density of  $350 \pm 55$  bits per track inch at a speed of over 80 inches per second on the 260-foot length reel. Each line on the tape is read or written in approximately  $33\frac{1}{2}$  microseconds. Simultaneous writing occurs in the two redundant mark and timing channels. **Capacity for 190,000 12-bit words in blocks of 129 words.**

### DECTape CONTROL 552

The Type 552 DECTape Control operates up to four Type 555 Dual DECTape Transports (8 drives). Binary information is transferred between the tape and the computer in 12-bit computer words approximately every  $133\frac{1}{3}$  microseconds. In writing, the control disassembles 12-bit computer words so that they are written at four successive lines on tape. Transfers between the computer and the control always occur in parallel for a 12-bit word. Data transfers use the data break (high speed channel) facility of the computer. As the start and end of each block are detected by the Mark track detection circuits, the control raises a DECTape (DT) flag which causes a computer program interrupt. The program interrupt is used by the computer program to determine the block number. When it determines that the forthcoming block is the one selected for a data transfer, it selects the read or write control mode. Each time a word is assembled or DECTape is ready to receive a word from the computer, the control raises a data flag. This flag is connected to the computer data break facility to signify a break request. Therefore, when each 12-bit computer word is assembled, the data flag causes a data break and initiates a transfer. By using the Mark channel decoding circuits and data break facility in this manner, computation in the main computer program can continue during tape operations.

**Transfers require 4.5% of PDP-5 cycles and 1.2% of PDP-8 cycles after the initial 200 millisecond start time.**

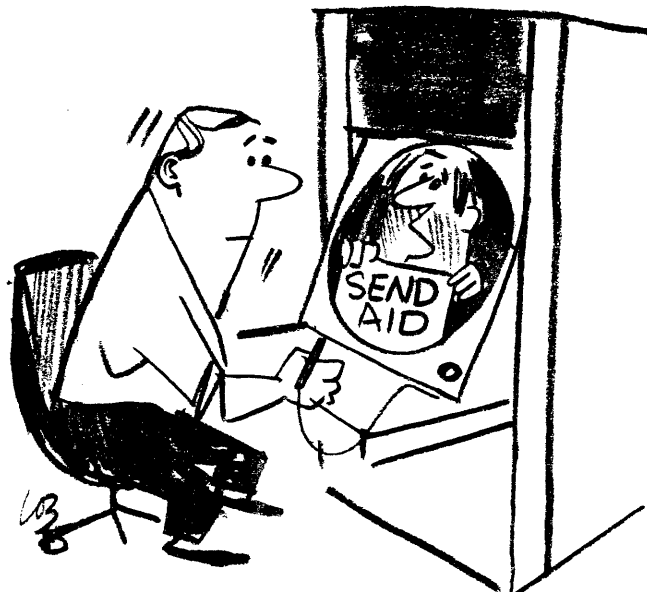

# DECUS PROGRAM LIBRARY

## PDP-1 PROGRAM LIBRARY ADDITIONS

### DECUS NO. 81

Title: CalComp Plotter Software for the PDP-1

Author: Adams Associates

Submitted by: Group 22, M.I.T. Lincoln Laboratory

Programming Language: MACRO

Hardware Requirements: CalComp Plotter, 16K Core Memory, 16 channel sequence break system, 800 B.p.i. magnetic tape.

Comments: This system was produced for Group 22, M.I.T. Lincoln Laboratory. The system consists of a set of subroutines that drive a CalComp Plotter. There are 4 output options: (1) the system generates a magnetic tape that is used in conjunction with a 1401 to drive the plotter; (2) the magnetic tape can drive the plotter directly using a CalComp System 670-80; (3) the magnetic tape can be reread by the PDP-1 to drive the plotter on-line; (4) the plotter can be driven by the PDP-1 directly on-line. Listings, flow charts and examples are included in the 111-page manual. Tapes for the subroutines are also available.

## PDP-4 PROGRAM LIBRARY ADDITIONS

### DECUS NO. 4-11

Title: Engineering Project Scheduling System

Author: Robert Vernon, M.I.T./DEC

Description: The Project Scheduling System is an engineering planning guide with an automated updating feature. The purpose of the system is to coordinate the engineering effort, both internally and with the various service departments of the company.

Specifically, the system will:

- a. serve as a planning guide to the engineer by helping him to coordinate the various activities within his project;
- b. provide the chief engineer with up-to-date information concerning the projected utilization of engineering manpower;
- c. provide other departments such as Drafting, upon whose services engineering depends, with up-to-date forecasts of workload requirements; and
- d. provide a basis for estimating the engineering budget.

The Engineering Project Scheduling System consists of:

1. a graphical schedule for each project,
2. a program for updating the schedules, and

3. a series of computer-generated reports which indicate the latest revision of the project manpower requirements.

A complete write-up, paper tapes and listings are now available from the DECUS Program Library.

### DECUS NO. 4-12

Title: BOOLEPAC

Author: Donald Sordillo, Harvard University

Description: The only Boolean functions directly implementable by the PDP-4 are:

Negation or NOT; implemented by CMA

Union or AND; implemented by AND

Exclusive or; implemented by XOR

Boolepac allows these and other Boolean functions\* to be implemented on the PDP-4 (and PDP-7). The general calling scheme is:

Lac (first argument

BFN

/the function name

Lac (second argument

The function defined in Boolepac are as follows:

Inclusive or	IOR	$A \vee B$
Stroke (not and)	NAND	$A B$ or $\overline{AB}$
Neither-nor	NOR	$\overline{A \vee B}$ or $A B$
Implication	COND	$A \supset B$
Equivalence	IFF	$A \equiv B$
Non-implication	NCOND	$\sim (A \supset B)$

\*Excluded from Boolepac are the trivial or easily implementable functions: 1,  $\emptyset$ , A, B.

## PDP-5 PROGRAM LIBRARY ADDITIONS

### DECUS NO. 5-18

Title: Bin Tape Disassembler for the PDP-5\*

Author: John W. McClure, Lawrence Radiation Laboratory, Livermore, California

Description: This program disassembles a PDP-5 program, in Bin format, on punched paper tape. The tape is read by a high-speed reader, but the program may be modified to use the ASR 33 reader. The margin setting, address, octal contents, mnemonic interpretation (PAL), and the effective address are printed on the ASR 33 teletype.

\*Work performed under the auspices of the U. S. Atomic Energy Commission.

# NEW DECUS MEMBERS

## PDP-1 DELEGATE

Richard J. McQuillin  
Inforonics Inc.  
Maynard, Massachusetts

## PDP-4/7 DELEGATE

Jerome A. G. Russell  
The Institute of Medical Sciences  
Research Data Facility  
San Francisco, California

## PDP-5/8 DELEGATE

Richard C. Reyna  
Dymec Division  
Hewlett-Packard Company  
Palo Alto, California

## PDP-5 DELEGATES

Stanley L. Davenport  
Chrysler Corporation-Space Div.  
New Orleans, Louisiana

Dr. Ernest Malamud  
Physics Dept. - University of Arizona  
Tucson, Arizona

ir. H. Broekhuis  
Royal Netherlands Blast Furnaces  
and Steelworks Ltd.  
IJmuiden - The Netherlands

David E. Wagner  
U. S. Naval Weapons Laboratory  
Dahlgren, Virginia

S. R. Penstone  
Queen's University  
Kingston, Ontario

Sumner Billings  
Fischer & Porter Company  
Warminster, Pennsylvania

Dr. R. H. Goodman.  
Department of Mines and  
Technical Surveys  
Ottawa, Ontario

B. G. Mathis  
North American Aviation, Inc.  
Tulsa, Oklahoma

W. W. Lee, Jr.  
Union Carbide Corporation  
Nuclear Division  
Oak Ridge, Tennessee

## PDP-7 DELEGATES

J. C. Lisle  
Manchester University  
Physical Laboratories  
Manchester, England

Laszlo von Hamos  
Royal Institute of Technology  
Stockholm, Sweden

N. E. Wiseman  
Cambridge University  
Mathematical Laboratory  
Cambridge, England

## PDP-8 DELEGATES

Dr. R. J. Ellison  
Manchester University  
Physics Department  
Manchester, England

Alistair R. McKenzie  
Standard Telephones & Cables Ltd.  
Enfield, Middlesex, England

A. G. McNamara  
National Research Council  
Ottawa, Canada

John Strand  
Ann Arbor Computer Corporation  
Ann Arbor, Michigan

Dr. D. Luers and L. Kvasz  
Max Planck Institut  
Munich, W. Germany

## INDIVIDUAL MEMBERS

Robert P. Abbott  
The Institute of Medical Sciences  
Research Data Facility  
San Francisco, California

Marilyn R. Avery  
A.E.R.E. Harwell  
Didcot, Berkshire, England

D. William Berte  
Donald C. Loughry  
Dymec Division  
Hewlett-Packard Company  
Palo Alto, California

Edward N. Chase  
Charles W. Adams Associates Inc.  
Cambridge, Massachusetts

## INDIVIDUAL MEMBERS (Continued)

R. L. A. Cottrell  
Manchester University  
Physical Laboratories  
Manchester, England

Douglas A. Didier  
Vincent L. Foxworthy  
Jay W. Fickes  
Systems Research Laboratories, Inc.  
Dayton, Ohio

K. I. Gordon  
D. H. B. Consulting Engrs.  
Montreal, Quebec

James Heaton  
Ann Arbor Computer Corporation  
Ann Arbor, Michigan

Robert W. Hockenbury  
Rensselaer Polytechnic Institute  
Troy, New York

Paul M. Kjeldergaard  
University of Pittsburgh  
Pittsburgh, Pennsylvania

Charles A. Laszlo  
David H. Moscovitch  
O.T.L. Research Laboratories  
Royal Victoria Hospital  
Montreal, Quebec

Dr. J. V. Oldfield  
University of Edinburgh  
Edinburgh, Scotland

Dr. Abram Petkau  
Whiteshell Nuclear Research Estb.  
Pinawa, Manitoba

N. van der Vlugt  
Royal Netherlands Blast Furnaces  
and Steelworks Ltd.  
IJmuiden, The Netherlands

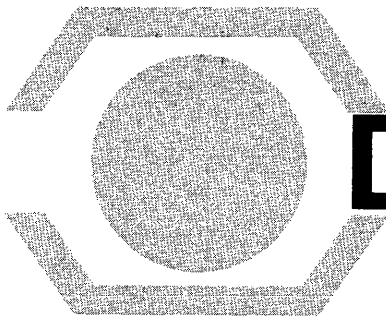

# DECUSCOPE

DIGITAL EQUIPMENT COMPUTER USERS SOCIETY  
MAYNARD, MASSACHUSETTS / TEL. 897-8821 / TWX 710 347-0212

JUNE 1965  
Vol. 4 No. 6

## GRATITUDE

DECUS wishes to express gratitude to the many persons who made the 1965 Spring Symposium possible. Thanks to our hosts, Harvard University, and particularly, Dr. Donald Norman and his capable staff. Thanks to our guest speakers, Mr. Harlan Anderson, Professor Steven Coons and Dr. James Oliver, for their particularly interesting presentations. Thanks to the authors for the unusually high quality of papers presented, and to the individual attendees for making the conference an interesting and stimulating experience.

William A. Fahle  
DECUS President

\* \* \* \* \*

## IT'S YOUR SOCIETY

We hope that none of our readers loses sight of the fact that DECUSCOPE is intended to communicate ideas not only to but among the DECUS membership. Without member participation, we can send each month a volley of technical material, but never really know if we are on target. We urge you to help shape DECUSCOPE as a medium of communication for the membership and a forum for ideas in data processing. Send a description of your computer applications or experimental results. Submit programs, subroutines and artful programming packages. Address open technical questions to the membership. Above all, we would like to hear your ideas on what should be included each month on the pages of DECUSCOPE. Write to the editor or to the publications committee and help to enlarge the channels of communication.

Joseph T. Lundy  
Publications Chairman

## A MESSAGE FROM THE DECUS PRESIDENT

Regarding the 1965 DECUS Spring Symposium

The 1965 DECUS Spring Symposium was enjoyable, instructive and challenging. This in itself is complete justification for the conference; however, since it is reasonable to examine such an undertaking in terms of purpose, the following question is posed: How well did the 1965 DECUS Spring Symposium fulfill the objectives of DECUS as specified in the bylaws? To answer this, the objectives are reviewed.

Objective 1 - To advance the art of computation through mutual education and interchange of ideas and information.

The important words here are "through mutual education." The symposium was encyclopedic in its educational material. The conferences provided useful information about such matters as graphic communication, metallurgy, nuclear research, typography, accounting, and oceanography. The road to better communications and idea interchange among DECUS members is through better understanding of the goals and problems of the individual DECUS installations. This understanding was furthered both at the sessions and during the luncheons, coffee breaks, and social hour.

Objective 2 - To establish standards and to provide channels to facilitate the free exchange of computer programs among members.

This objective is best accomplished by functions of DECUS other than the symposia. However, due to the relaxed and friendly surroundings, those who attended the meeting were in a good position to find out authoritative details about particular programs in the library. Several general-purpose display programs, monitor, and assembly systems were described in detail during the sessions.

Objective 3 - To provide feedback to the computer industry on equipment and programming needs.

If the 1965 DECUS Spring Symposium is to be remembered for anything, it will be remembered as the first time that a symposium was used effectively to provide this feedback. Mr. Harlan Anderson of Digital Equipment Corporation delivered an address covering the present status and future goals of DECUS. A panel of DEC representatives was there for a sound-off session which was so well executed and received that its major fault seems to have been that it was about an hour too short.

It can only be concluded that the symposium brought DECUS

(continued on page 2)

closer to its goals. The picture painted in this article may appear a bit rosy; there probably were certain flaws and faults. But the general picture that remains with each attendee is that of a worthwhile, educational and enjoyable symposium in a congenial atmosphere.

William A. Fahle  
DECUS President

## DECUS BUSINESS

-A Summary of Recent Committee Meetings-

### Executive Board Meeting

An Executive Board Meeting was held on April 21st at C. W. Adams Associates in Bedford. The following members attended: John T. Gilmore, Jr. (Adams Associates), Richard McQuillin (Inforonics), Joseph Lundy (Inforonics), Jack Brown (Bolt Beranek and Newman), Elsa Newman, and Angela Cossette (DEC). Mr. William Fahle, DECUS President, was not able to attend and appointed Mr. Gilmore to act as his proxy. Several topics were discussed. The main ones being: final preparations for the Spring Symposium, nominations, bylaw changes and the possibility of providing a user configuration service through DECUS. Separate Nomination and Bylaw Committees were set up. The Bylaws Committee consisted of: Richard McQuillin (Chairman), Joe Lundy, Elsa Newman and Angela Cossette. The Nominations Committee consisted of: Jack Brown (Chairman), Dick McQuillin and Jack Gilmore. During the meeting, Dick McQuillin gave an account of the recent JUG Meeting (ACM) which he attended as the delegate for DECUS.

### Nominations Committee

The Nominations Committee met on April 26th to determine possible candidates for DECUS office. A tentative slate was set up, but was not finalized due to the fact that nominations could also be made during the Spring Symposium and for one month following. Nomination forms were sent out to all members for their convenience in making their nominations for office. The final slate of candidates will be published in DECUSCOPE and ballots will be sent to all delegates.

### Bylaws Committee

After review by the members of the committee, Mr. McQuillin drew up the proposed changes which included:

1. The provision for two secretaries - a recording secretary (elective) and an executive secretary (to be provided by Digital with the approval of the Executive Board) and the duties of each.
2. Duties of Standing Committee Chairmen.
3. Provision for an elected Publications Committee Chairman.
4. Terms of office.

The Board favored two-year terms for all the elected offices. A suggestion was made to have newly elected officers take

office on January 1st instead of during the Fall DECUS Meeting. The proposed changes will be submitted to the delegates for approval.

### Business Meeting - Spring Symposium

The business meeting held at the Spring Symposium was presided over by William Fahle, DECUS President. Mr. Fahle discussed the growth of DECUS during the past four years and then each committee chairman was called upon to give a report.

Dick McQuillin described the proposed changes in the by-laws and what each particular change entailed.

Jack Brown talked about the status of nominations and asked for additional nominations from the floor. Several names were placed in nomination.

Jack Gilmore discussed the time and place for the Fall Meeting. A suggestion was made to hold the meeting on Monday, November 29 (the day before the opening of the Fall Joint Computer Conference) in either Las Vegas or San Francisco. No definite decision was made at this time. Any suggestions from the membership are welcome.

## PROGRAMMING NOTES

### WANTED

CalComp Plotter Routines for the PDP-4/7 and PDP-5/8. Please contact the DECUS Office.

### PARITY CHECKING ON THE CONTENTS OF THE AC

By: Sid Penstone, Queen's University  
Kingston, Ontario

The following is a routine for checking the parity of a number in the AC.

```

      .
      . /Number in AC
      .
      cll
parity, szl
      cma
      rar
      spa
      cma
      sza
      jmp parity
      . /Exits with AC zero after
      . /all bits checked
      . /Link = 0 for even parity
      . /Link = 1 for odd parity

```

DECUSCOPE is published monthly for Digital Equipment Computer Users Society (DECUS).

Material for DECUSCOPE should reach the editor before the 7th day of the current month for publication in that issue.

DECUSCOPE is published in Maynard, Massachusetts.  
Editor: Angela Cossette, Digital Equipment Corporation  
Publications Chairman: Joseph Lundy, Inforonics, Inc.  
Present Circulation: 1000 copies per month

## GRAY CODE TO BINARY CONVERSION

From: Jon Stedman, Lawrence Radiation Laboratory  
Berkeley, California

```
GRAY CODE TO BINARY CONVERSION
/
/ LAC GRAY NUMBER
/ JMS GRAY
/ RETURN WITH AC = binary number
/
requires 1.1 milliseconds per conversion

gray, 0
dac grat /save gray number
lam -21
dac gnat /set loop count
lac grat

gray00, cllVspa
gray01, jmp gray01
gray11, rcl /bits are same
isz gnat /count bit
jmp gray00 /loop
jmp i gray /exit

gray10, spa
gray01, jmp gray11
stl /bits are different
ral
stl
isz gnat /count bit
jmp gray10 /loop
jmp i gray /exit

grat, 0 /gray number storage
gnat, 0 /bit counter
start
```

Algorithm Reference: System Module Manual (DEC)  
Page 2.19

## NEWS ITEMS

### STANFORD TO USE LINC COMPUTER

The School of Medicine (Department of Pharmacology) at Stanford University will use a LINC (Laboratory Instrument Computer) on and off line in the analysis of experimental data. The data will come from evoked and spontaneous electrical activity in the nervous systems of mammals subjected to learning situations and to a variety of drugs of interest in the treatment of the mentally ill. The computer will be used with low-level, low-frequency biological amplifiers, analog tape systems, and operant conditioning equipment.

Planned analytical techniques include conventional forms of time series analysis and averaging, as well as less conventional techniques adapted to problems of pattern recognition.

\*\*\*\*\*

## RENSELAER TO USE PDP-7 FOR NUCLEAR EVENT STUDIES

Rensselaer Polytechnic Institute will use PDP Multianalyzer in investigations of subatomic particle interactions. The university's Department of Nuclear Science and Engineering is performing the research for the Reactor Division of the Atomic Energy Commission.

The Multianalyzer will be used with Rensselaer's 45-200 megawatt linear accelerator and pulsed magnet deflection system for time-of-flight and pulse-height analysis.

In the pulse-height studies, energy spectra of machine-induced nuclear reactions are analyzed by detecting, measuring, recording, sorting, and summing the individual energies of particles thrown off from the sample under test.

In the time-of-flight studies, particles derived from the accelerator and scattered by a sample under test are timed as they travel along a known distance. This information enables the scientist to determine their velocity distribution and, therefore, their energy distribution after scattering. This knowledge provides an insight into the dynamics of molecular motions in the samples under study.

Cross-sectional and reactor-type time-of-flight experiments with slow and fast neutrons are to be performed using the Multianalyzer, which makes possible a time-compression sampling of energy spectra. In this configuration, a portion of the PDP-7's memory is used as a derandomizing buffer. Input data from detectors and time scalars is deposited in this buffer area in the form of a list. Later the list is processed to increment the channels in the data portion of memory corresponding to the various times at which events were recorded.

List processing of the data lends itself well to time-channel compression, enabling the experimenter to gather and examine extremely detailed information about the high-energy channels without sacrificing coverage of other channels.

\*\*\*\*\*

### UNIVERSITY WILL USE PDP-7 TO STUDY LEARNING SITUATIONS

The Learning Research and Development Center of the University of Pittsburgh will be using a PDP-7 computer in an experiment control application. The work in which the PDP-7 will function is research into computer-based instruction. The computer will control special-purpose console devices developed at the university to analyze learning situations.

Previous experiments utilized simple logic devices of limited capacity to sequence either printed or filmed subject matter--turning pages of a book, for example, or running a slide projector automatically. Use of the computer is expected to provide greater flexibility for the experimenters.

\*\*\*\*\*

# DECADE

CHARLES W. STEIN

DIGITAL EQUIPMENT CORPORATION

## ABSTRACT

DECADE (Digital Equipment Corporation's Automatic Design System) is the result of an effort to perform engineer/computer communication via a display and light pen. This system provides the interface between man and machine using the general language of schematic drawing. Coupled with the system are some analysis programs which can produce wire lists, automatic wiring machine cards, and parts lists. The system is general enough to allow user-written analysis programs.

## THE SYSTEM

M.I.T., Boeing, I.B.M., C.D.C., United Aircraft, and Lockheed, among others, are involved in "Computer-Aided Design." Magazine articles illustrate computer-aided design by showing a man sitting at a computer-driven scope, holding a light pen and displaying on the screen a bridge, an automobile, airplane wings, or some such complex mechanical device.

This type of system is suitable for an aircraft or bridge building company. However, there are many firms which need a smaller version of computer-aided design for the problems which tend to be more specific such as schematics. Some companies are devoted to schematic drawing almost exclusively, while others spend eighty to ninety per cent of their time producing schematic drawings. We feel that if a man could give such a drawing to a computer, rather than a generalized mechanical drawing, he could reduce his company's drafting effort considerably. Furthermore, if some programs existed which analyze the schematic and produce listings, other areas of the company's design effort would be reduced.

DECADE permits such input on low-cost hardware. Schematic drawings can be sent to the computer through the use of a Teletype, light pen, and push-button control.

We define a schematic as the graphic representation of a system in terms of a set of standard symbols. Lines connect groups of symbols to indicate some relationship between them. Text is used to describe the symbols and connections. A programming flow chart, a PERT chart, a logic diagram, and a wiring diagram all fall into our definition of schematic. Schematic drawing was chosen because many of the problems inherent in the general system are eliminated. In the past, computer-aided design systems required a large-scale, general-purpose computer; however, when we limit the input to a schematic, less core storage is needed. With the replacement of magnetic tapes with DECTapes, the system's cost is reduced further.

Less core storage is required in DECADE than in the general system for the following reasons:

1. The standard symbols are topologically defined within themselves. The fact that a symbol is a resistor says many things that the general system must state in full each time a resistor is called.
2. Since the set of symbols is predefined, we need only to prescribe it once in core.

For example:

It is not necessary to duplicate all the vectors which

draw a resistor each time one appears on the screen; we only need a call to the resistor subroutine which draws and defines it.

There are advantages in having a small computer system. Computer-aided design is now within the reach of many smaller firms which could not afford a large system. DECADE will sell for approximately \$200,000. Although it performs a smaller task, this task now costs industry millions of dollars. By speeding up many of the jobs now done manually, we reduce both the cost and the frequency of error.

## THE HARDWARE

The figure below shows a sketch of the basic hardware configuration.

DECADE HARDWARE

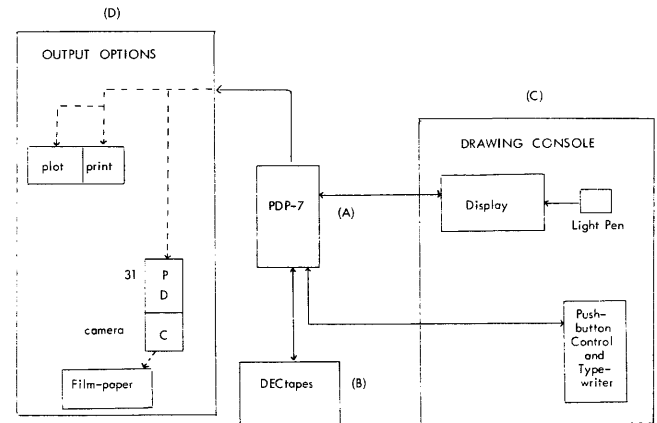

1. 8K PDP-7 Computer
2. Four DECTape Drives
3. Console
4. Output Option

The console consists of a display and light pen, teletype, and push-button controls.

The system must provide some means for hard copy output. The desired output is in two forms: schematic drawings and printed output. There are two output options. The first consists of a line printer and a display-driven CalComp Plotter. The second uses the Type 31 Ultra-Precision (4096 x 4096 grid) Display, computer-controlled camera and automatic film processor, and film-to-hard-copy equipment.

## SOFTWARE

The software package is divided into two parts. The first part is the information retrieval system (IRS) which is used to keep track of the drawings already done on the system. The second part is the actual graphical input program (GIP). Using the light pen, typewriter, and push buttons, the user can "draw" some type of schematic.

## SYMBOL GENERATION

Each symbol has been given a tag or name. To call a symbol on the screen, the user types "G." The system will type back three spaces, and then the user types in the tag and a line feed.

When a symbol is called, it appears in the lower left corner of the screen.

The system provides for the use of a 22" x 34" drawing. It is obvious that it would be impossible to draw this size drawing on a 9-inch square screen; thus, we have two scales of magnification. Scale 0 shows the entire 22" x 34" drawing, greatly reduced. Displayed in the picture is a 2 1/4" square. Imagine this as a picture frame and position the frame over some section of the drawing. Depressing SCL causes that section to be blown up four times. Depressing SCL again returns you to the original scale.

The standard drafting procedure is to pick a section of a drawing, blow it up, and work on it until it has been completed; then move the frame and resume. A symbol can be called on the screen at both scales. Typing G and then the tag causes the symbol to be "live." There is a table which keeps track of the "live" symbols. The CLR button clears this table. The "live" symbols are affected as a group by the POS, ROT, DUP, DEL, YES, and NO buttons. The "live" symbols are brighter than the others.

Another way to produce a "live" symbol is with the SEL or select button. The buttons POS, ROT, DUP, DEL, YES, and NO, operate on "live" symbols.

## TEXT

Generally, there are three types of text information: symbol descriptions, connection descriptions, and drawing descriptions. Text is displayed as a block of characters which are positioned left justified to the light pen. It is necessary that the system understand which type of text the user wants, therefore, we use the light pen to point either to a symbol, connection, or nothing (space). If the user moves the light pen, the text received thus far will move with it. Typing the carriage return key, the user returns to a point directly under the light pen. When the text is in and positioned properly, a line feed terminates the message. From then on, the text block is dependent on the item it references. If the text references a symbol and the symbol is moved or deleted, the text moves or disappears also. In the case of text which references the drawing, it is stationary and should be thought of as a symbol.

## CONCLUSION

A man-machine interface system which operates on a small computer has been described. This system is currently under development, and is by no means the final version of the system.

Below are a few refinements:

1. One problem is that most companies have huge amounts of information now on microfilm. A desirable program would be one which reads microfilm and recognizes patterns to generate semi-automatically the internal topological structure of that drawing.
2. Some general-purpose routines need to be written which would work on the data. Examples of such programs might be a PERT/COST System, a FLOW CHART COMPILER, a WIRE LIST GENERATOR, a PARTS LIST GENERATOR, and many others. As one works with the system, new applications become apparent. The information necessary is in core or on tape for any of these systems.

3. With additional core, a time-sharing system could be written which would swap the internal list structure in and out of core and could handle many consoles. This task would be easier if the 338 Buffered Display were used. It would be necessary, however, to make the system sensitive to more than one control console. Then, the required description could be loaded from drum, modified, and shipped to the 338.

This system is general enough that a multitude of problems could be solved.

## ***Automated Television Computer-Scanner To Identify Bacteria, Infectious Agents***

A novel automated "television-computer" machine for identifying bacteria, viruses, and other infectious agents and for studying their properties and requirements will be constructed at the University of California, Berkeley, with funds from the Public Health Service.

A 5-year program is planned, at an estimated total Federal cost of \$1.24 million, with a first-year grant of \$629,038. The grant supporting the project will be administered by the National Institute of General Medical Sciences.

The main purpose of the program will be to make an intensive study of the hereditary characteristics of bacteria and other microorganisms. The study will aim to find out what minerals, vitamins, and foods they need to survive; what drugs, poisons, and other agents they are able to resist; and their behavior at high and low temperatures, under various lighting conditions, and under exposure to a variety of environments.

### **Studies Provide Clues**

Results of these studies may provide important clues as to how these smallest of all living creatures function and how they evolved into their modern forms.

The automated system, which will include a high-speed electronic scanner-computer, may enable physicians to diagnose bacterial and other microbial diseases in one-third to one-fourth of the time now required. This could save many lives now lost because of delays in beginning specific drug treatment pending diagnosis.

The program, proposed by Dr. Donald A. Glaser, Professor of Physics and Molecular Biology at the university, will be under his immediate direction. The objective of Dr. Glaser's program is to construct a high-speed electronic scanner-computer for automatic "visual" observation and analysis of

medical specimens and biological systems.

This "television-computer" combination, he said, hopefully will make it possible for a research laboratory or a hospital to incubate a specimen for only 12 to 18 hours before identifying and counting the numbers of bacteria of each known kind contained in the specimen. This now usually takes about 48 hours.

### **Scanner Speeds Process**

The time reduction could be accomplished by noting the colony structure, rate of growth on various nutrients, and other characteristics by means of the scanner, which will be able to make determinations with high precision and great speed even on very small colonies.

"Once this identification has been made," Dr. Glaser pointed out, "the computer can direct the automatic petri dish machine to spray penicillin and a variety of other drugs on the growing microbial colonies in order to determine the drug sensitivities of possible disease-causing organisms which are found."

With this automatic system, it is believed that identification of the causative organism and determination of its drug sensitivity or resistance can be made much faster and with higher reliability than is possible with present hospital techniques.

It is expected that essentially the same techniques will be useful for monitoring levels of contamination of food, water, and medical supplies where it is important to know how many living organisms are present and of what kinds.

Reprinted from the NIH Record,  
May 18, 1965, Vol. XVII, No. 10

---

Editor's Note: The computer (mentioned in the above article) which will be used by Dr. Glaser in his experiments is the PDP-6.



# COMPUTER OPTIONS

## PROGRAMMED BUFFERED DISPLAY TYPE 338

The Digital Equipment Corporation Type 338 Buffered Display permits rapid conversion of digital computer data into graphic and tabular form. Its combined capabilities offer the user an unusual degree of versatility and accuracy.

A self-contained unit with built-in control and power supplies, the Type 338 requires only logic level inputs for operation and may be easily connected to any digital system as a buffered display with processor, or it may stand alone as a powerful computer-driven display system. Location of any desired point may be specified by any of the 1024-X and 1024-Y coordinate addresses contained in a 9-3/8" square on the tube face. Discrete points may be plotted in any sequence at a rate of 30  $\mu$ sec per point in the point mode. In the increment, vector, vector continue, and character modes, a plotting rate of 1  $\mu$ sec per point is possible. Magnetic deflection and focusing techniques result in uniform resolution over the entire usable area of the tube face and maximum spot size of approximately 0.15" when measured by shrinking raster techniques. Construction is solid state throughout with excellent stability.

The 338 Buffered Display is a stored programmed system that was designed with the programmer in mind. Some of the capabilities of the display are listed below.

**DATA ACQUISITION BY CYCLE STEALING** The display receives 12-bit data and control words from the PDP-8 memory via the PDP-8 data break channel. The Data Break Channel is a high-speed (1.5  $\mu$ sec/word), direct access channel that passes words to the display transparently to the program in execution.

**DISPLAY MODES** Each display mode, such as vector, increment, character, point, vector continue, or short vector, specifies the manner in which points are to be displayed on the screen.

**CONTROL STATE** All modes can specify that the display enter the control state in which 12-bit words are decoded as instructions to change display parameters, change mode, or change the address of access to the computer memory.

**AUTOMATIC SCISSORING** The display can be programmed to represent a 10" x 10" square window viewing a 6' x 6' drawing. This window can easily be moved around the drawing by simple translation of coordinates. Only the area of the 6' x 6' drawing corresponding to the 10" x 10" display window will be seen.

**MULTILEVEL SUBROUTINING** The control state permits the display to jump from accessing one location in the PDP-8 memory to any other. When it is desired to jump to a display subroutine, the return address is automatically stored in a push-down list.

**AUTOMATIC SENSING OF DISPLAY FLAGS** Control state also permits the display to jump conditioned on the states of its own flags (light pen flag, edge flag, stop flag, etc.). This reduces the number of program interrupts to the PDP-8.

**AUTOMATIC CHARACTER GENERATION** In addition to automatic line generation, the display hardware can display characters specified by 6-bit codes. Each character is displayed in an average of 15  $\mu$ sec.

**COMMUNICATION WITH DISPLAY REGISTERS** The contents of the x-y position registers and the display address counter can be read into the accumulator of the PDP-8 via IOT instructions. Likewise, the display used for starting the display or setting up certain control conditions.

All of the above features tend to make the programming job for a given application easier. The programmer not only has a powerful computer to generate the display, to control interfaces to external data sources, or to handle real-time requests, but he also has a powerful display that can operate at a high degree of independence from the computer.

## COMPUTER INTERCOMMUNICATION SYSTEM TYPE 165

The 165 series options provide a data intercommunication path between PDP-6 arithmetic processors/memories and up to eight PDP-7 or PDP-8 computers. PDP-6 arithmetic processors directly address (to read or write data) the

PDP-7 or PDP-8 memories as PDP-6 memory (with only 12- or 18-bit words). These peripheral computer memories have both their own address, and addresses in the PDP-6 addressing space.

Jobs or data may be set up in a peripheral computer, then a flag set to interrupt PDP-6, followed by PDP-6 computation using the PDP-7 or 8 memory. Data may be block transferred from 36-bit memory to 12- or 18-bit memory using the block transmission instruction, programs may be loaded from PDP-6 memory into peripheral computer memories under control of the PDP-6 Monitor, etc.

Interrupt flags can be used to interrupt either PDP-7/8 or PDP-6. Two sets of flags are provided for each PDP-7/8.

The functions performed by the peripheral computers might include I/O control, Teletype control and formatting, display maintenance, data gathering, etc. while the PDP-6 would coordinate peripheral efforts, do block computation, and serve as the main job processor.

# DECUS PROGRAM LIBRARY

## PDP-1 PROGRAM LIBRARY

### Correction to DECUS No. 81 - CalComp Plotter Software the PDP-1

Change:

Programming Language to: Midas

Hardware Requirements to: Calcomp Plotter, 4K Core  
Memory, 800 bpi mag-  
netic tape

## PDP-5 PROGRAM LIBRARY ADDITIONS

### DECUS NO. 5-19

Title: DDT-5-2 OCTAL-SYMBOLIC DEBUGGING  
SYSTEM

Author: Michael S. Wolfberg, Moore School of Electric  
Engineering, University of Pennsylvania

Description: DDT-5-2 is an octal-symbolic debugging program for the PDP-5 which occupies locations 5600 through 7677. It is able to merge a symbol table punched by PAL II and stores symbols, 4 locations per symbol, from 5577 down towards 0000. The mnemonics for the eight basic instructions and various OPR and IOT group instructions are initially defined (see DEC-5-1-5 Attachment II, p. 21), and the highest available location for the user is initially 5373.

From the Teletype, the user can symbolically examine and verify the contents of any memory location. DDT-5 allows the user to punch a corrected program in BIN format.

DDT-5 has a breakpoint facility to help the user run sections of his program. When this facility is used, the debugger also uses location 0005.

This program has nearly all the features of DDT for the PDP-1. The meaning of the control characters of ODT (DEC-5-5-5) are the same in DDT-5.

## PDP-7 PROGRAM LIBRARY ADDITIONS

### DECUS NO. 7-2

Title: FAST START

Author: P. Bevington, Stanford University

Description: FAST (Fast Acquisition of System Tapes) is a monitor written for the DEC PDP-7 to retrieve frequently used programs from DECtape. The FAST monitor includes three programs:

1. The FAST Loader writes information into the first block of a DECtape, listing for each of the programs stored on that tape: (a) the starting block for each program, (b) the first location in memory occupied by the program, (c) the number of locations allocated, and (d) the starting location.
2. The FAST Writer transfers a program from the computer memory to the portion of DECtape specified by the first block.

3. The FAST Reader transfers a program from DECtape into the computer memory in the locations specified by the first block of DECtape.

The FAST Writer and FAST Reader are general programs, but the FAST Loader contains the information specified above which must be modified to suit particular programs.

In normal use, once the FAST Loader and FAST Writer have prepared a DECtape for system use, only the FAST Reader need be utilized; this program is commonly designated FAST.

FAST occupies memory locations 17600 - 17747, the portion normally allocated to the Funny Format Loader. Most programs therefore will not destroy FAST. However, the Assembler overlays FAST with the Funny Format Loader which it cannibalizes for its own use, and the Fortran Compiler wipes out portions of FAST if the programs compiled are complex enough. For convenience, the Read-In version of FAST loads the RIM Loader as well (locations 17762 - 17777), but this is almost never destroyed.

If any program containing a Funny Format Loader is read into the computer through RIM START, this will destroy FAST. Conversely, FAST will destroy the linking loader of a Fortran main program, so that subroutines will not be loaded properly. When using FAST with Fortran programs, therefore, FAST should be loaded after all subprograms and the library have been loaded. It can then be used to call the Operating Time System.

### DECUS NO. 7-3

Title: CUS - CONSOLE UTILITY SYSTEM

Author: Allen Rousseau, Adams Associates

Description: CUS is an octal debugging and utility system. It consists of the following routines.

1. Octal Correcting Routines - to examine and/or correct the contents of any core memory location with the option of punching a correction tape in RIM mode.
2. Word Search Routine - to examine the contents of a specified portion of core memory for a particular bit pattern and print the address of the register (or registers) if found.
3. Octal Dump - to print and/or punch (in RIM mode) the contents of a continuous section of core memory specified by the user. The print-out is 1-8 words per line as specified by the user.
4. Compare Tape Equal Routine (What's Changed) - to compare a RIM tape with the corresponding area of core memory and type out the contents of the tape and core words which differ. The contents of core memory are not altered. What's changed can be used to verify a newly punched tape or compare current memory contents with a previously punched tape for debugging.
5. Jump Options - The user may jump to any location in memory with interrupt on and off.
6. Transfer Routine - permits transfer of any section of core to some other section.
7. Fill Routine - Permits filling of designated area of core with desired octal constant.

# NEW DECUS MEMBERS

## PDP-4 DELEGATES

Miss Eleanor M. Bowey  
Linear Accelerator Group  
Nuclear Physics Division  
Atomic Energy Research Establishment  
Harwell  
Berkshire, England

Peter N. Martino  
Chase Brass and Copper Company  
Montpelier Division  
Montpelier, Ohio

## PDP-5 DELEGATES

Francis L. Durfee  
Penn-Dixie Cement Corporation  
Petoskey, Michigan

Michael S. Wolfberg  
Moore School of Electrical Engineering  
University of Pennsylvania  
Philadelphia, Pennsylvania

## PDP-5/8 DELEGATE

David I. Benton  
The Foxboro Company  
Natick, Massachusetts

## PDP-6 DELEGATE

Heinz Weber  
Physikalisches Institut  
Technische Hochschule  
Aachen, Germany

## PDP-7 DELEGATE

George T. Torrero  
Aeronutronic  
Division of Philco Corporation  
Newport Beach, California

## PDP-8 DELEGATES

Gordon F. MacGinitie  
Granger Associates  
Palo Alto, California

R. S. Robinson  
Psychiatry Department  
Stanford University School of Medicine  
Stanford, California

## INDIVIDUAL MEMBERS

R. D. Egan  
Granger Associates  
Palo Alto, California

Larry T. Gell  
Chase Brass and Copper Company  
Montpelier, Ohio

Robert L. Gill  
Penn-Dixie Cement Corporation  
Petoskey, Michigan

Robert Glaser  
Learning Research and Development Center  
University of Pittsburgh  
Pittsburgh, Pennsylvania

Nancy L. Hurley  
Bolt Beranek and Newman, Inc.  
Cambridge, Massachusetts

C. A. Josling  
Department of Mines and  
Technical Surveys  
Ottawa, Ontario

Thomas C. Lowe  
Moore School of Electrical Engineering  
University of Pennsylvania  
Philadelphia, Pennsylvania

Stephen F. Lundstrom  
Applied Dynamics  
Ann Arbor, Michigan

Dr. James R. Oliver  
University of Southwestern Louisiana  
Lafayette, Louisiana

Walter A. J. Miller  
Chase Brass and Copper Company  
Montpelier, Ohio

Robert T. Rizzo  
29 Concord Avenue  
Cambridge, Massachusetts

Stuart L. Sharpe  
United Aircraft Corporation  
Research Laboratories  
East Hartford, Connecticut

Paul Weinberg  
University of Pennsylvania  
Philadelphia, Pennsylvania

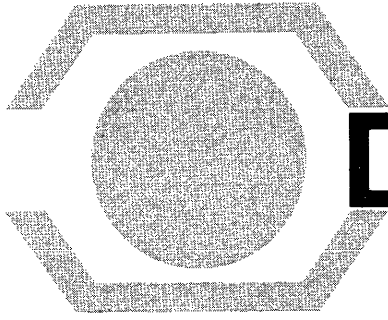

# DECUSCOPE

DIGITAL EQUIPMENT COMPUTER USERS SOCIETY  
MAYNARD, MASSACHUSETTS / TEL. 897-8821 / TWX 710 347-0212

JULY-AUGUST 1965  
Vol. 4 Nos. 7 and 8

## CLINICAL APPLICATIONS OF COMPUTERS

David H. Brand

Systems Research Laboratories Inc.

Dayton, Ohio

### INTRODUCTION

Clinical Applications of Computers presents in moderate detail those areas considered important in providing the physician medical assistance by way of computers. These areas in order of development are: patient monitoring, data reduction, and medical diagnosis. Many of the classic problems are given with an expose of inadequate, state-of-the-art solutions. Concluding remarks outline the most probable long-range plan for successfully "marrying" the physician and the computer.

Ever since serious thought has been given to computer applications in medicine (dating back to 1954 and 1955, such articles as "Use of Record Cards in Practice, Prescription, and Diagnostic Records" by Baylund and Baylund and "Diagnosis by Slide Rule" by Abbot Laboratories), attempts have been made to provide better clinical support to the physician via a digital computer. Techniques by necessity have been vague due to the subjective nature of processes found to be effective by the physician. Attempts at developing these techniques have pretty well covered the gamut of issues which are of concern to the physician in the three aforementioned areas.

Engineers, as well as "systems" people, have contributed to designing computers which are more easily accessible to the physician. The result has been an active competition for a small digital computer with an inherent flexibility of stored programs, the speed of larger computers, and an abundance of analog input/output. Within the past year, we have witnessed the announcement of several such computers all of which have characteristics similar to the AFCRL LINC. An important common feature is the digital display which is capable of presenting waveforms in a manner useful to the physician and is the major output device for computation results.

### PATIENT MONITORING

What is patient monitoring? Let us think of it as a technique

which enables a physician to evaluate certain aspects of patient condition at any time. The distinction between monitoring (in a "right now" sense) and regression to past responses is certainly clear both in concept and method. Patient monitoring represents the ultimate in patient care assuming that the evaluation based on the data is correct and can incorporate the non-quantifiable subjectivity of the physician to filter out the unwanted transients and polish the results or interpretations.

The potential benefits of patient monitoring are clear. Unfortunately the methods are not and many National Institutes of Health dollars, as well as United States Air Force dollars, have been spent for the purpose of clarifying these methods. In other words, much effort has been expended in attempting to answer the simple question: what is an effective way to monitor a patient? a very sick patient? In engineering terms, then, the question becomes: how can we best collect and display time-variant patient information?

In general, there is a mismatch between the physician and the computer. This particular problem is slowly being resolved by appropriate man-machine interaction techniques which are finding their way into various medical journals and medical school curricula. Most of these techniques emphasize the need to reach a conceptual level of communication which is closer to the physician than to the computer. An example of one such communication technique is an analog display of trend with outstanding "points of interest" clearly marked.

However, the real difficulty in patient monitoring is not the communication problem, which is a finite time-consuming factor in designing useful systems; but rather is the determination of what comprises a useful system. This difficulty can be divided into four parts.

1. The inability to easily, accurately and continuously measure the body functions which are given to be important in evaluating patient condition.

2. The inability of the physician to understand and interpret second-to-second or beat-to-beat variations within a body function regardless of which one.
3. The determination of what data to save and what to ignore realizing that it is currently impractical to record all data. This difficulty would be reduced if adequate mathematical models and alarming conditions for physiological responses were available.
4. The realistic inaccessibility of data - both present and past - to the modern physician.

Presently, we know how to measure many body functions, or variables, satisfactorily. Surface electrodes in most cases are sufficient to derive electrocardiograms, electromyograms, pulse waveforms, etc. Consequently, there is little reason to question ease and accuracy in sensing body variables and related measures which result from surface transducer methods. There is reason, however, to question the meaning of most of these surface measurements to the physician. Today's physicians readily agree that the concept of high resolution of variation in most body measurements (heart rate, core temperature, blood pressure, etc.) is too new to have physiological meaning. What does the heart rate average over the last ten minutes really mean? Or, how about the frequency distribution of the systolic blood pressure over the past eight hours?

The new dimension of available, or potentially available, physiological data is overwhelming. Medical electronics has been concerned with the high resolution measurement of standard, clinical variables. But, for patient monitoring purposes, are these really the variables which are important in evaluating patient condition? Probably not. A consensus of several prominent physicians, who have supported the patient monitoring issue, is that the list of monitored variables must include measures of state of consciousness, cardiac output, and venous pressure. Currently, direct, continuous measurement of any of these three is not possible. Dr. Neil Burch, Baylor University, has been working on what he calls an EEG signature recognition device which has been designed to quantify, more or less, the state of consciousness. Mathematical models to give cardiac output and other cardiac variables indirectly from surface measurements have not yet been refined to the point of general usefulness, thus, cannot be used for patient monitoring.

Determining what data to save is as important as determining what data to collect. One certainly cannot afford to save all of the data and, in fact, most of the data does not contain enough new information (as defined by current techniques) for the physician to evaluate in terms of unusual patterns or change phenomena. What, then, do we keep? What information is useful in deciding patient condition? It is probably not so-called "out-of-limits" data which perturbs the basic physiological system to the extent of endangering its stability. Some may ask: what is a limit? How can patient monitoring inform a physician of an "alarming" condition?

Many experiments have been tried regarding the development of optimal alarming devices for the purposes of reducing the amount of data considered while monitoring patients. These have involved setting upper and lower bounds somewhat arbitrarily, but based on experience. The idea is to sound an alarm (perhaps physically with a bell or buzzer) whenever the physiological measurement crosses the boundaries. For example, a physician may feel that a heart rate below 40 or above 120 is particularly distressful for a certain patient. Thus, he would be informed--by some

means--of every instance when the heart rate was out of limits. People who have tried this, as well as other esoteric devices, under the auspices of National Institutes of Health and other agencies have withdrawn their efforts--hopefully temporarily--in disappointment and dismay. The inherent nature of man defies simple description of system instability; thus, confounds the problem of data storage for effective patient monitoring.

The problems in data storage are linked closely with those problems encountered in data reduction, which is discussed later. We can assume, for now, that we have successfully quantized meaningful physiological variables. The fourth area of patient monitoring difficulties is in the accessibility of the data to the physician. The modern physician tends to be "on the go." He might have two or three offices and work in several different hospitals. In short, he is hard to find; and when he is available, he desires finger-tip knowledge of the condition of all his patients.

Discussions with medical people, in particular at the M. D. Anderson Hospital and Tumor Institute in Houston, Texas, who are among the leaders in patient monitoring studies, have resulted in helpful suggestions regarding the design of special "data-call" devices which would be of use to the physician. Most agree that a unit similar to that used in a stockbroker's office providing nearly instantaneous current and historical information with pushbuttons is desired. As long as we are going automatic, we might just as well ask for the ultimate in data recall techniques.

## DATA REDUCTION

Having collected waveforms from a patient, you must decide which variables are important for analysis or hypothesis testing. This decision, initially, must be based on waveform resolution and accuracy. In other words, what variables can be derived from the waveforms collected? The data reduction issue, as mentioned earlier, handles problems encountered in data storage. The amount of storage required for physiological information is generally inversely related to the amount of data reduction performed as the term "data reduction" would imply. Thus, the decision regarding techniques of data reduction are secondarily based on amount of storage available, and the hypotheses to be tested.

The variables which can be derived dictate empirically the hypotheses which can be tested. If the physician is not able to significantly expand or refine the set of possible hypotheses which he can test regarding patient condition, he will reject the technique merely on the basis of simple logic: if it is not better, why bother? Thus, we get back to the question involving the state-of-the-art in medical instrumentation vs. interpretation of obtainable physiological variables by today's physicians from which we shall digress.

Mentioned previously, external body measurements are easy to obtain via surface electrodes. Thermistors are good for minute temperature changes all over the body, and good approximations to core temperature can be made externally. Temperature is an absolute quantity which requires no reduction. Electromagnetic and mechanical waveforms require reduction in order to resolve meaningful variations. The absolute measurements desired in these cases are intervals (or frequency) and other points of interest which contain relative rather than absolute information in their variability. Examples are R-R interval and T-slope from the electrocardiogram, alpha and beta rhythm from the electroencephalogram, and breathing rate and inspiration-expiration ratio from the respiration wave.

Neil Burch's work at Baylor promises to be a great step forward in the development of automatic data reduction techniques useful in deriving discrete points-of-interest variables from continuous waveforms. His latest efforts include so-called signature recognition devices for galvanic skin responses, electrocardiograms, and electroencephalograms. In essence these devices are special-purpose analog computers with digital readouts which give beat-to-beat measurements as well as selected time interval measures. For patient monitoring, the signature recognition data reduction technique applied to surface waveforms represents, as far as I know today, state-of-the-art in efficient physiological data handling.

## MEDICAL DIAGNOSIS

An extremely controversial subject of the day in terms of computers and medicine is the utilization of a computer for medical diagnosis. As yet, medical diagnosis represents an extremely complex decision-making situation which defies automation. Many have tried to assign mathematical order to the diagnostic process, but in general have failed even though, in a few isolated cases, blood and heart diseases have been successfully detected by computers.

The theory of decisions and their processes offer a potentially vast spectrum of tools with which mathematicians can approach the diagnosis problem. This is evident from the many fine papers by Ledley and Lusted on techniques of decision processes as applied to medical diagnoses. The earliest of these was entitled "Reasoning Foundations of Medical Diagnosis" in July 1959 issue of Science and is an excellent expose on the subject with some very comprehensive, yet easily understandable, examples and illustrations. This particular paper has been "sitting on the shelf" for over five years. Refinements of the techniques have been suggested in subsequent articles but essentially are just tastier frostings on the same cake.

The method Ledley and Lusted use incorporates a Bayesian statistical approach with subjective probabilities. Downstream in the later stages of medical diagnosis they use game theory with the usual elements of expected value functions and minimax solutions to a two-person, zero-sum game. The two persons are the physician and nature and the payoff matrix has symptom rows and disease columns. The elements of the payoff matrix are proportioned probabilistically from empirical data--in other words, a symptom and a disease related by a probability. Granted there are gross assumptions necessary in this approach but currently it represents a likely kind of solution.

Another technique was presented in May of 1964 at the Second Annual Symposium in Biomathematics and Computer Science in the Life Sciences by Martin Lipkin on "The Likelihood Approach in Differential Diagnosis." Lipkin found that the maximum likelihood solution to a medical diagnosis was slightly more efficient than the Bayesian solution in identifying rare diseases when the symptom-disease conditional probability is not very strong.

The problems in automating medical diagnosis are many and elusive. The basic problem is that today's physicians are not prepared to accept the mathematical model required to automate the diagnosis even though many want to accept it. They need more mathematical statistics and probability early in the stages of their training--at the undergraduate level. Baylor University is in the planning phase of remedying this deficiency and recently there were tentative recommendations made for the undergraduate mathematics program of students in the biological sciences.

Another problem is definite need for more symptom-disease data to refine estimates of conditional probabilities. In practical treatment, however, the physician often arrives at a therapy without a diagnosis. It is accepted without concern that the disease is not named provided the therapy resolves it. Thus, in these instances there is no such thing as a diagnosis which resulted from associating symptoms with a disease, the cure of which is straightforward. The therapy proceeds directly from symptom changes using an inductive process in competing hypotheses which is called differential diagnosis. Computer assistance would be preferred in this area.

## CONCLUSION

My concluding remarks are in terms of the current outlook for the future application of computers in medicine. Many researchers are optimistic and have adopted the "around the corner" attitude. Nothing which represents a worthwhile, universal application is just around the corner. It will, at best, take almost another generation of physicians to bring the future of computers in medicine into a strong position where the principal tool of the average physician is a computer.

The conversational teaching machine approach by Mr. Wallace Feurzeig and Associates at Bolt Beranek and Newman, Inc. presented in the June 1964 issue of Datamation appears to be an excellent start of a long term program to bring the physician closer to the computer and closer to accepting the real worth of the speed of computers.

The computers of tomorrow useful in clinical applications certainly, will be parallel processors and hybrids.

## BIBLIOGRAPHY

1. Caceres, "Integration of Data in Diagnosis," Circ. Res. 11, September 1962.
2. Clynes, "Use of Computers for Physiological Discovery and for Diagnosis by Dynamic Simulation," Circ. Res. 11, September 1962.
3. Cogswell, "Clinical Diagnostic Models via Computer Simulation," SDC, AD286730, September 1962.
4. "Computer Procedure as Aid in Diagnosis," J. Am. Med. Assoc., 185, 4, July 27, 1963.
5. DeHaven, "A Study of Blood by Chemical Analysis and by Digital Computer: a Comparative Evaluation," Rand Corp., AD400923, July 1963.
6. "Electronic Diagnosing Device Displayed by Soviets," Electronic News, February 1960.
7. Graziano, "Medical Diagnosis with Electronic Computers: an Annotated Bibliography," Lockheed Aircraft, AD407945, October 1963.
8. Klienmetz, "A Portrait of the Computer as a Young Clinician," Behav. Sci., Vol. 8, April 1963.
9. Ledley and Lusted, "Medical Diagnosis and Modern Decision Making," Proc. Symp. Appl. Math. Am. Math. Soc., Providence, R. I., Vol. 14, 1962.
10. Ledley and Lusted, "Medical Diagnosis Aided by Digital Computers," Proc. 1961 Comput. Applications Symp., Chicago, October 1961.
11. Lipkin, "The Likelihood Approach in Differential Diagnosis," Second Annual Symp. on Biomath. and Comp. Sciences in the Life Sciences., May 1964.

12. Lusted, "Applications of Computers in Diagnosis," Circ. Res., 11, September 1962.
13. Lusted, "Data Handling, Computers, and Diagnosis," Proc. IRE., Vol. 50, May 1964.
14. Overall, "Criteria for Evaluating Diagnostic Decision Making," Second Annual Symp. on Bimath. and Comp. Sciences in the Life Sciences, May 1964.
15. Pipberger, H., "Problems in Computation of Differential Diagnosis for ECG." Second Annual Symp. on Bimath. and Comp. Sciences in the Life Sciences, May 1964.
16. Sterling, "Clinical Applications in Medicine," Digest of Tech. Papers ACM Nat. Conf., Syracuse, N.Y., September 1962.
17. Wheeler, "Base Line for Evaluating Automatic Equipment. Is it Good for the Patients?" Hospitals, 36, September 1962.
18. Woodson, "The Concept of Competing Hypothesis in Medical Diagnosis," Second Annual Sym. on Bimath. and Comp. Sciences in the Life Sciences, May 1964.

#### EDITOR'S NOTE

This article was the last of three initial presentations given during a panel discussion on PDP Applications in Medicine and Biology held at Wright-Patterson Air Force Base, Ohio during the DECUS Fall 1964 Symposium. Because we were not able to print the complete panel discussion, it was not included in the Proceedings of the meeting.

## CALL FOR PAPERS

Inserted in this issue is the "call for papers" for the Fall 1965 DECUS Symposium. We ask that you post this announcement or circulate it within your installation. Thank you.

DECUS Meetings Committee

DECUSCOPE is published monthly for Digital Equipment Computer Users Society (DECUS).

Material for publication should be sent to: Mrs. Angela J. Cossette, DECUS, Maynard, Massachusetts 01754.

Publications Chairman: Joseph Lundy, Inforonics, Inc.

Circulation: 1,400 copies per month

## PROGRAMMING NOTES

### PROGRAM EVALUATION (DECAL-BBN)

R.J. Zavadil, Air Force Technical Application Center

We have been using DECAL-BBN exclusively since receipt of the September 1963 version, and it has performed quite well.

The Linking Loader supplied operates satisfactorily; however, the reader clutch chatters excessively. The Linking Loader has been patched to read with no wait for a completion pulse and to use the status bit for program synchronization. This seems to be a worthwhile change.

The Libetape Maker works satisfactorily; however, it will sometimes start to execute and try to read the tape before sense switch 5 is changed. This may be a hardware problem with our PDP-1 and has not been traced any further.

The DECAL-BBN compiler works very well except for the following troubles:

1. A subroutine that begins:

```
table:      loc table-1
subrx'      dap exit
```

The "loc" instruction compiles incorrectly. The instruction part of the word contains 77 instead of 00.

2. A program:

```
org 7634
getter'     law 200
           .
           .
           body of program
           .
           .
startsys'   jmp main
           jmp getter ... this instruction is in
           address 7777
```

The instruction "jmp getter" in address 7777 does not load correctly. The address part contains 7777 instead of the address of getter.

3. A program:

```
at ewd 0000
           .
           .
           body of program
           .
           .
adr at = adr1
           .
```

The line "adr at => adr1" does not compile correctly. It compiles as:

```
dac 0744 ... the address 0744 is
generated by DECAL as
law 0744 ... a tmp storage area
dac adr1
```

The line should compile as:

```
law at  
dac addr1
```

4. A program that uses a floating-point interpreter:

```
.  
.  
body of program  
.  
efm 2  
lac a  
sub b  
dac c  
lfm  
.  
efm  
lac a  
add b  
dac b  
lfm  
jmp somewhere
```

The last occurrence of "efm" does not have a number specifying the number of words for floating-point values. After the tape is read by DECAL, it goes into a loop and punches unending blank tape.

#### NESTED DO LOOPS

Jim Miller, Dow Badische Chemical Company

A programming possibility that is not covered in the FORTRAN manual is to have a nested DO loop with a variable limit.

For example, suppose a DO loop has been initiated:

```
;DO 20 J=1,11
```

It is possible to have a DO loop nested:

```
;DO 10 L=1,J
```

Where J is changed, of course, on each cycle through the major DO.

#### PROGRAM FOR CHECKING PARITY OF 36-BIT NUMBERS WITH EAE INSTRUCTIONS

Philip R. Bevington, Stanford University

```
                /Number in AC + MQ  
cll  
rar  
parity, norm  
sna  
jmp .+4  
and (1777777)  
cml  
jmp parity  
                /Exits with AC=MQ=0  
                /After bits checked  
                /Link = 0 for even parity  
                /Link = 1 for odd parity
```

## NEWS ITEMS

### INTERNATIONAL SYMPOSIUM

A symposium on Economics of Automatic Data Processing will be held in Rome on October 19-22, 1965, at the International Computation Centre. The sessions will be held in three forms: plenary sessions, panels, and general and symposium sessions. The papers presented will be in English and French. For further information and advance programs write to:

Symposium on Economics of ADP  
International Computation Centre  
Viale della Civiltà del Lavoro, 23  
P.O. Box 10053  
Rome (E.U.R.) Italy

### DIGITAL PROGRAM LIBRARY NEWS

Recently, the latest version of PDP-8 Abstracts was mailed to all PDP-5/8 installations. Users who did not receive a copy or who need additional copies should contact Miss Joan Cowles, Digital Program Librarian.

Changes or additions to this list will be published in future issues of DECUSCOPE; and periodically, updated lists will be mailed to the PDP-5/8 installations. New users will receive the latest abstracts in the write-up notebook sent with each computer.

### PDP-7 FOR PHOTO ANALYSIS STUDIES

The Aeronutronics Division of Ford Motor Company in Newport Beach, Calif., will be using a PDP-7 computer for use in an experimental film-scanning operation.

A long-term goal of the work is to mechanize and automate as many of the steps as possible in detecting and analyzing the data contained in aerial photographs. Shortening the time needed to perform the mapping task in scanning films is an example of the improvements that may be possible through using computer techniques.

A processor built by Aeronutronics for U.S. Army Engineer Geodesy, Intelligence and Mapping Research and Development Agency of the Corps of Engineers will gather data from the film-scanning and forward it to the PDP-7 for manipulation and analysis. Various readouts from the PDP-7 will be available to provide the experimenters with analytical results developed by the computer for study by interpreters.

### CAMBRIDGE UNIVERSITY USING DISPLAY SYSTEM

The Mathematical Laboratory of Cambridge University is using a display control system for research into man-machine communications and computer-aided design.

The system consists of a PDP-7 computer with 8192-word core memory and an incremental CRT display and light pen. The display functions as a subcomputer, obtaining data and instructions directly from the PDP-7 core memory. It has random point, vector, increment, and other plotting modes.



## DECUS PROGRAM LIBRARY

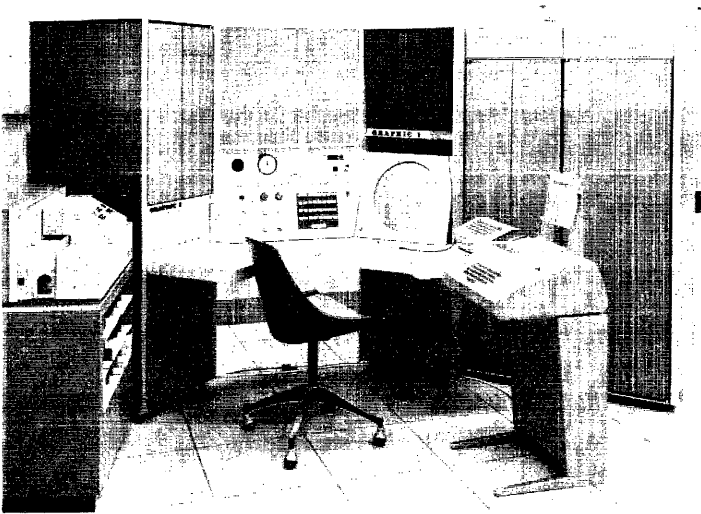

### COMPUTER SYSTEM TO PROCESS GRAPHICAL INFORMATION

Pictured above is the PDP-5 Computer and Type 340 Precision Incremental CRT Display system installed in the Signal and Information Processing Research Department of the Bell Telephone Laboratories, Murray Hill, New Jersey.

The computer and display form the heart of a new interaction system which will be used both to enter and to receive graphical data in the Laboratories' Computing Center. This interaction system has access to the main computational facilities between normal problem runs.

A core buffer will be used to store output information for display on the scope and to receive new input information so that the display system functions independently between interactions. The PDP-5 computer monitors the display operation and also controls a Type 370 High Speed Light Pen for use in entering or modifying data.

Other elements of the system are Digital's Type 137 Analog-to-Digital Converter and Type 451A Card Reader and Control.

The purpose of the system is to allow quick looks at graphs, diagrams, and other information and to facilitate the rapid interchange of information between problem solver and computer needed in man-machine interaction problems.

### STOCKHOLM ROYAL INSTITUTE OF TECHNOLOGY TO STUDY ADAPTIVE CONTROL WITH PDP-7 SYSTEM

The Division of Automatic Control, headed by Professor L. von Hamos, at the Royal Institute of Technology in Stockholm, Sweden, will use a PDP-7 computer primarily to solve problems by hybrid simulation in conjunction with analog computers and/or real-time equipment. The main problems will be development of self-adaptive and learning-control systems and also the study of biological control mechanisms. Opportunity will also be provided for other scientists to use the computer.

### PDP-1 PROGRAM LIBRARY ADDITIONS

#### DECUS No. 82

Title: FORTRAN for the PDP-1

Authors: Developed by the Air Force Technical Applications Center (AFTAC) and the Geotechnical Corporation.

The FORTRAN Compiler for the PDP-1 is not intended to be a replacement language for the other compiler and assembly languages already in use on the PDP-1; however, it is useful for short programs which may easily be coded in FORTRAN. Version I of the FORTRAN system for the PDP-1 uses *mus* and *dis* instructions; and *mpy* and *dvd* subroutines. Version II is for *mpy*, *dvd* and hardware.

### PDP-5 PROGRAM LIBRARY ADDITIONS

#### DECUS No. 5/8-20

Title: Remote Operator FORTRAN System

Author: James Miller, Dow Badische Chemical Company

Program modifications and instructions to make the FORTRAN OTS version dated 2/12/65 operated from remote stations.

#### DECUS No. 5/8-21

Title: Triple Precision Arithmetic Package for the PDP-5 and the PDP-8

Author: Joseph A. Rodnite, Information Control Systems, Inc.

This is an arithmetic package to operate on 36-bit signed integers. The operations are add, subtract, multiply, divide, input conversion, and output conversion. Triple precision routines have a higher level of accuracy for work such as accounting. The largest integer which may be represented is  $2^{35} - 1$  or 10 decimal digits. The routines simulate a 36-bit (3 word) accumulator in core locations 40, 41, and 42 and a 36-bit multiplier quotient register in core locations 43, 44, and 45.

Aside from the few locations in page 0, the routines use less core storage space than the equivalent double-precision routines.

#### DECUS No. 5/8-22

Title: DECTape DUPLICATE

Author: E. Jacob, Dow Badische Chemical Company

This is a DECTape routine to transfer all of one reel (transport 1) to another (transport 2). This program occupies one page of memory beginning at 7400. The last page of memory is not used during the operation of the program, however, the memory from 1 to 7436 is used to set the DECTape reels in the proper starting attitude and is then destroyed during duplication. Duplication will commence after which both reels will rewind. Parity error will cause the program to halt with 0040 in the accumulator.

## DECUS No. 5/8-23

Title: PDP-5/8 Oscilloscope Symbol Generator

Authors: Norman Weissman and John Kiraly, NASA-Ames, Moffett Field, California

- Specifications:
1. BIN with parity format or PAL BIN
  2. Length - registers 200-577 (octal)
  3. Oscilloscope display unit

The subroutine may be called to write a string of characters, a pair of characters, or a single character on an oscilloscope. Seventy (octal) symbols in ASCII Trimmed Code and four special "format" commands are acceptable to this routine. The program is operated in a fashion similar to the DEC Teletype Output Package.

Binary tape with parity format, PAL binary tape, Assembler listing, and cards for an LRL Assembly are available.

## PDP-7 PROGRAM LIBRARY ADDITIONS

### DECUS No. 7-4

Title: PTSCOPE, PTPEN, PTPLOT, CALIBRATE, LISTEN

Author: P. Bevington, Stanford University

PTSCOPE is a FORTRAN subroutine for the PDP-7 for displaying a single parameter spectrum once on an oscilloscope using the Type 34 Display. It automatically normalizes the spectrum to a specified scale factor (which may be taken from the console switches) and spreads the spectrum over a specified portion of the oscilloscope face. It scales the spectrum point by point to avoid the necessity of providing storage room for a normalized spectrum. Display rate is 60  $\mu$ sec per point, limited by the Type 34 Display. Every tenth channel is intensified by a factor of 4. This subroutine depends on the speed of the PDP-7 with Extended Arithmetic Element to display properly.

PTPEN is a FORTRAN subroutine for the PDP-7 compatible with PTSCOPE for identifying channel numbers in spectra displayed with PTSCOPE, using the Type 370 Light Pen. It displays a cross on the face of the oscilloscope which may be positioned with the light pen. The channel number corresponding to the position of the cross is returned to the main program. The cross may be positioned to one channel in 1024 even with fairly coarse collimators on the light pen. This subroutine is written in mixed FORTRAN and PDP-4/7 symbolic. Light pen flag skip and clear are 700701 and 700702, respectively.

PTPLOT is a FORTRAN subroutine for the PDP-7 for plotting a single parameter spectrum on an X-Y plotter using the Type 34 Display. Normalization and scaling of the spectrum are identical with that of PTSCOPE. In both cases, full-scale deflection is assumed to be 1000 (decimal). However, since the increments along the X-axis are 1/4-inte-

gral, spectra with channel numbers not exact fractions of 4000 will not span 1000 exactly. For example, spectra with 1024 channels will span 1024 full scale, and spectra with 128 channels will span 960 full scale. This subroutine is written in mixed FORTRAN and PDP-4/7 symbolic and utilizes EAE instructions for normalization. It assumes 0 yields a full-scale deflection to allow the plotter to reach a null.

CALIBRATE is a FORTRAN subroutine for the PDP-7 compatible with PTPLOT for calibrating the full-scale deflection of a plotter connected to a Type 34 Display. It plots at the rate of about 1 per second at a corner of the plot, specified by the Teletype keyboard, assuming full-scale deflection is 1000 (decimal).

Typing 1, 2, 3, or 4 will position the plotter at the corner with  $(X,Y) = (0,0), (0,1), (1,1),$  or  $(1,0)$ , respectively. Typing anything else will stop the plotting and cause a return to the main program. This subroutine is written in mixed FORTRAN and PDP-4/7 symbolic. It assumes 0 yields a full-scale deflection and 1777 (octal) yields no deflection.

LISTEN is a FORTRAN subroutine for the PDP-7 to permit access to numbers from the Teletype keyboard without the provisions of waiting if there is no input. Its main use is to provide a branch from a program such as PTSCOPE, where the desirability of branching is indicated by typing a number on the keyboard, and the location of the branch is indicated by the number typed. This subroutine is written in mixed FORTRAN and PDP-4/7 symbolic. It assumes the input is from Type 33 or 35 Teletypewriter in ASCII code.

### DECUS No. 7-5

Title: KINEMATICS

Author: P. Bevington, Stanford University

KINEMATICS is a FORTRAN subroutine for use with nuclear reactions to transform energies, angles, and cross sections nonrelativistically between the laboratory system and the center-of-mass system. The notation and calculations are taken from 1960 Nuclear Data Tables, part 3, pp. 161, 162. Given the masses of incident, target, and emitted particles of a two-body reaction, and the incident energy, KINEMATICS will calculate the energy of the emitted particle in both systems, the ratio of cm/lab cross sections and the angle in one system if the angle in the other system and the Q value are given, or it will calculate the Q value, the ratio of cm/lab cross sections, and the emitted energy and angle in the cm system if the emitted energy and angle in the lab system are given. This subroutine is written entirely in FORTRAN, with no symbolic instructions.

### DECUS No. 7-6

Title: CGC FUNCTION

Author: A. Anderson, Stanford University

The CGC (Clebsch Gordan Coefficient) subprogram is designed to be used with FORTRAN programs running under the Operating Time System on the PDP-7. It calculates angular momentum vector coupling coefficients with the phase conventions of Condon and Shortley.

# NEW DECUS MEMBERS

## PDP-1 DELEGATE

Edsel G. Crenshaw  
Radio Corporation of America  
Moorestown, New Jersey

## PDP-5 DELEGATES

John H. Holland  
C.A.R.D.E.  
Quebec, Canada

Robert Scott, Jr.  
SPERT Data Processing Group  
Phillips Petroleum Company (A.E.D.)  
Idaho Falls, Idaho

## PDP-6 DELEGATES

G. E. Bryan  
The RAND Corporation  
Santa Monica, California

William B. Easton  
Applied Logic Corporation  
Princeton, New Jersey

## PDP-7 DELEGATES

Edgar A. Bates  
Stromberg-Carlson Corporation  
San Diego, California

H. Briscoe  
F. Heart  
P. Fleck  
M.I.T. Lincoln Laboratory  
Lexington, Massachusetts

Joseph M. Fontana  
University of Alabama Medical Center  
Birmingham, Alabama

G. W. Gear  
University of Illinois  
Department of Computer Science  
Urbana, Illinois

Mrs. Phylis F. Niccolai  
Carnegie Institute of Technology  
Nuclear Research Center  
Saxonburg, Pennsylvania

M. Pleeging  
Technological University - Delft  
Electrical Department  
Delft, Netherlands

Walter R. Smith  
The Boeing Company  
Aero-Space Division  
Seattle, Washington

## PDP-8 DELEGATES

Mark Q. Barton  
Brookhaven National Laboratory  
Accelerator Department  
Upton, New York

Mrs. Doris S. Ellis  
The Johns Hopkins University  
High Energy Physics Group  
Baltimore, Maryland

## PDP-8 DELEGATES (continued)

Ralph Norman Haber  
University of Rochester  
Center for Visual Science  
Rochester, New York

Shinichi Kawase  
Yokogawa Electric Works, Ltd.  
Tokyo, Japan

Lawrence B. Leipuner  
Brookhaven National Laboratory  
Cosmotron  
Upton, New York

William B. Marks  
The Johns Hopkins University  
Biophysics Department  
Baltimore, Maryland

Donley R. Olson  
Rocketdyne, Div. of N.A.A.  
Canoga Park, California

Thomas B. Sheridan  
Massachusetts Institute of Technology  
Man-Machine Systems Group  
Cambridge, Massachusetts

Ronald Tevonian  
Western Electric Company  
Engineering Research Center  
Princeton, New Jersey

## INDIVIDUAL MEMBERS

John C. Alderman  
Brookhaven National Laboratory  
Cosmotron  
Upton, New York

Jonathan Allen  
Bell Telephone Laboratories  
Murray Hill, New Jersey

Roger E. Anderson  
Lawrence Radiation Laboratory  
Livermore, California

Thomas Bottegai  
University of Pittsburgh  
Pittsburgh, Pennsylvania

S. M. Chase  
University of Illinois  
Urbana, Illinois

Lewic C. Clapp  
Computer Research Corporation  
Belmont, Massachusetts

William R. Ferrell  
Massachusetts Institute of Technology  
Cambridge, Massachusetts

## INDIVIDUAL MEMBERS (continued)

John William Fitzgerald  
Stanford Medical School  
Stanford, California

Herbert I. Fleischer  
Bell Telephone Laboratories  
Murray Hill, New Jersey

Herbert Freeman  
New York University  
Bronx, New York

M. E. Haas  
University of Illinois  
Urbana, Illinois

Scott Herman-Giddens  
University of Alabama Medical Center  
Birmingham, Alabama

Don Hildreth  
Rocketdyne, Div. of N.A.A.  
Canoga Park, California

Gottfried L. Huppertz  
Max Planck Institute  
Munich, West Germany

Stephen G. Hussar  
University of Pittsburgh  
Pittsburgh, Pennsylvania

Dale E. Jordan  
Computer Research Corporation  
Belmont, Massachusetts

John E. Koch  
Phillips Petroleum Company (A.E.D.)  
Idaho Falls, Idaho

Melvin B. Langbort  
The Foxboro Company  
Natick, Massachusetts

Irving Nadelhaft  
Carnegie Institute of Technology  
Pittsburgh, Pennsylvania

Lee Ohringer  
University of Pittsburgh Computing Ctr.  
Pittsburgh, Pennsylvania

L. J. Peek  
Western Electric Company  
Princeton, New Jersey

Philip L. Rex  
Beckman Instruments Inc.  
Huntsville, Alabama

Mrs. Donald A. Watson  
Phillips Petroleum Company (A.E.D.)  
Idaho Falls, Idaho

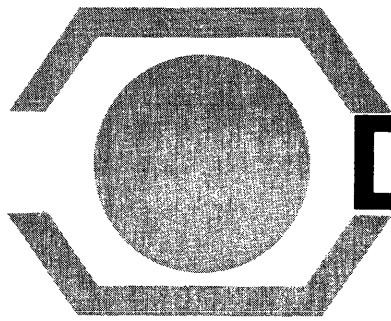

# DECUSCOPE

DIGITAL EQUIPMENT COMPUTER USERS SOCIETY  
MAYNARD, MASSACHUSETTS / TEL. 897-8821 / TWX 710 347-0212

SEPTEMBER 1965  
Volume 4 No.9

## A SCOPE TEXT EDITOR FOR THE PDP-7 / 340

N.E. Wiseman

University of Cambridge, Cambridge, England

This article describes the development of an experimental text editing program using the PDP-7 computer and 340 Display. The program is controlled by commands issued via the light pen and keyboard, and dynamic monitoring of the text is provided by the cathode ray display which serves as a 'window' into a selected area of the text. The action point for an edit function is determined by a conceptual pointer which may be positioned anywhere in the text. In its present form only 8-track paper tape documents in ASCII code may be handled, the program can, in principle, be used to edit in any code by adding new character subroutines to the symbol generator and making minor changes to the program steering tables.

### MODES OF OPERATION

The program operates in one of seven modes, and it may be convenient to outline the action in each mode before considering the detailed operation of the program.

Character Insert (I) - Characters typed on the teleprinter are inserted into the text to the right of the current pointer position and the pointer is then stepped on. The character RUBOUT, however, deletes the character above the pointer and steps the pointer back. Creation of new text and insertions, deletions, and changes over a small area of existing text would normally be carried out in I mode.

Block Insert (B) - This mode is used to manipulate text items larger than a single character. An invisible buffer capable of holding up to 192 characters is used to store a block of text and typed commands serve to kill the buffer, extract lines of text into the buffer, insert the buffer contents into the text and delete lines of text. The commands are:

- |   |   |
|---|---|
| K | kill the buffer   |
| E | extract text, from the character to the right of the current pointer position up to (and including) the next line-feed character, into the buffer and advance the pointer |
| I | insert the entire buffer contents into the text starting from the right of the current pointer position and advance the pointer   |

RUBOUT delete the line of text above the pointer position and back up the pointer.

Rearrangements of substantial sections of text would normally be carried out in B mode (possibly in conjunction with T mode).

Move Window (M) - Typing U or D causes the text to move up or down by 20 lines (i.e., about half a screen diameter). Normally, the pointer is then repositioned to the top lefthand character in the window. In this mode the program endeavors to maintain a window full of text by reading in paper tape as necessary. If a form-feed is encountered during read-in (indicating a page ending), the program switches to mode S and stops reading.

String Search (S) - A string of characters may be typed on the teleprinter and a forward search made through the text for the next line starting with characters matching the string. The search is initiated by typing colon (:). Typing (:) again will search for the next (forward) match on the same string. If a match is found, the window is repositioned with the matched line at the top of the display and the pointer at the beginning of this line. If no match is found, the window is not moved. Typing RUBOUT moves the window back to the start of the text.

Punch Text (P) - The contents of the text buffer are punched and the program then resets to I mode with all buffers empty.

Print Text (↑) - This is used to print selected parts of the text on the teleprinter (e.g., to obtain printed records of changes made). On entering this mode printing starts immediately, starting at the character to the right of the current pointer position and continuing either to the end of the text or until some light-pen action is taken (moving the pointer position, for example).

Type into Buffer (T) - Characters typed on the teleprinter are added into the invisible buffer. RUBOUT deletes the last character. A phrase to be used several times would be typed in T mode once only and then inserted in the text as many times as required by the use of block insert mode.

(Continued)

MODE SWITCHES

Near the top of the screen, above the text window, seven mode identifying characters are displayed. These are light buttons. Pointing with the light pen at one of these characters will cause it to enlarge to double size and the program to switch into the corresponding mode. Alternatively, the mode can be selected by typing / (slash) on the keyboard followed by the mode identifying character (note, however, that the identifying character for  $\uparrow$  mode is line-feed and not  $\uparrow$ ). With four exceptions, the program remains in a selected mode until it is changed manually by one of these two methods. The exceptions are:

1. At the completion of punching in mode P the program switches itself to mode I and resets itself.
2. During readin in mode M the program switches to mode S and stops the reader if a form-feed character is read.
3. If the invisible buffer is overfilled while typing in mode T, the program switches to mode  $\uparrow$  as a warning.
4. If the pointer is repositioned while in  $\uparrow$  mode, printing ceases and the program switches to mode I.

If two characters comprising a mode switch pair are required as a text item, the mode switch mechanism can be defeated by typing / <any non-control character> RUBOUT <desired character>. Note, however, that the character / is not accepted into the text until the following (non-control) character is typed.

TEXT POINTER

The text pointer appears as an underline symbol on the display and may be moved around in the window by either the light pen or keyboard. Pointing at a character in the text with the pen causes the pointer to underline that character. Note that invisible characters, e.g., space or carriage return, cannot be seen by the pen and thus cannot be marked by the pointer in this way. Keyboard commands /R and /L serve to step the pointer right and left respectively, by one character, enabling any character, visible or invisible, to be marked. Keyboard commands /D and /U move the pointer, forward and backward respectively, to the next line-feed character, i.e., down a line and up a line. Normally the pointer cannot be moved outside the display window. However, in the special circumstances where the pointer can go out-of-sight (reading paper tape in mode M can cause it to occur), a 'bogus' pointer is displayed at the top right of the screen above the window as a warning that the effect of any edit function will not be seen unless the window and/or pointer is repositioned.

TEXT STORAGE

The text is held in a circular buffer having a capacity of about 3000 characters. If additions are made to the text when the buffer is full, the head of the buffer is automatically punched out to make room for the tail. In this way arbitrarily large documents can be passed through the editor although access at any moment is limited to the most recent 3000 characters.

Characters are formed by closed display subroutines of from one to twelve words. They are 12 units high and spaced on a 12 unit pitch with a 24 unit line-feed and are constructed from vector segments in scale 1. All characters except T have approximately the same appearance on the display as they do on the teleprinter. TAB, however, is displayed as a double-size space to avoid the need for maintaining a dynamic column count in the program. It takes from 20 to 150  $\mu$ sec to display a character, depending on complexity. With typical program text about 1000, characters are displayed in the window at an average of 80  $\mu$ sec per character so that the display is replenished at about 12 points/second. This gives a very noticeable flicker to the display. It could be reduced in one of two ways:

1. A hardware symbol generator could be used. This would reduce the character time to about 15  $\mu$ sec and thus a 1000 character picture would be replenished at 60 points/second, well above the observable flicker rate.
2. Characters of poorer definition could be formed by using vectors in scale 2. This would roughly halve the average character time enabling 25 points/second for a 1000 character picture.

TEXT BUFFERS

Text is stored in the buffers as a linear list of calls to the appropriate character subroutines. Each call requires a two-word entry in the list:

1. Parameter word to set subroutine mode.
2. Display jump to a character subroutine.

This is a rather inefficient use of storage space, compared with the three characters per word obtainable from the use of a hardware character generator, and it seems desirable to use 'clean' programming techniques in manipulating the main text buffer in order to keep space for 3000 meaningful characters in the buffer at all times. In this way no garbage is generated and each text item always requires exactly two list entries. On the other hand, substantial data movement is involved in making insertions and deletions to the text. As an example, Figure 1 gives a flow diagram for a subroutine in the editor which inserts N words from an auxiliary buffer named BUFFB into the main buffer at the pointer position. The terminology is as follows:

BOTS	Address of numerically lowest register in main text buffer.
TOPS	Address of numerically highest register in main text buffer.
BTXT	Address of bottom of text in main text buffer.
ETXT	Address of top of text in main text buffer.
PNT	Address of pointer in main text buffer.
BOTA	Address of bottom register in BUFFA.
BOTB	Address of bottom register in BUFFB.

- A Incrementing address in BUFFA or BUFFB (depending on a program switch setting).
- B Incrementing address in BUFFB or BUFFA (depending on a program switch setting).
- N Number of words to be inserted from BUFFB into text.

To insert any number, N, of words (up to an auxiliary buffer full) starting at a point M words from the end of the main text buffer requires that  $2M + N$  words be moved. The inner loop in ACPTN has 14 instructions and takes about 50  $\mu$ sec per cycle. Thus, an insertion near the beginning of a full buffer takes about  $2 \times 6000 \times 50 \times 10^{-6} = 0.6$  seconds. This is in effect the response time to a keyboard request, and to the man initiating the request it seems quite fast enough. To a computer with nothing else to do, as in the present case, it is obviously of no consequence; but on a machine with a heavy independent workload the method would be entirely unacceptable and a structured non-consecutive buffer would have to be used.

BUFFC is used for input buffering and is in fact the invisible buffer mentioned earlier in connection with modes B and T. When the main text buffer overflows, the head is transferred to BUFFP for punching. Under normal circumstances editing can then proceed independently; but if continued overflow occurs so that BUFFP gets full, the program becomes dead until the punch has caught up. Thus the user is prevented from overfilling BUFFP by temporarily halting input to meet the limitations of the punch.

### PICTURE

Three display tables make up the picture:

1. A row of light buttons used for mode selection and indication.
2. A windowful of text.
3. A pointer positioned somewhere in the text.

When no other action is called for, the program simply sequences these three tables over and over.

The light button table is simply a string of special calls to the symbol generator. The calls are special in that the scale, light-pen status, and absolute position are set specifically for each character. When the program is in a particular mode, the identifying button for that mode is displayed in scale 2 and disabled (i.e., made invisible to the light pen), while the other buttons are displayed in scale 1 and enabled. Thus a pen 'see' on a particular button is serviced only once even though the button table may be displayed many times during the pointing action.

The text buffers are arranged so that a minimum of processing is required to select and display a windowful of text. The beam is simply positioned at the top left corner of the window, and the display is started at some position STXT in the main text buffer. When the beam runs off the bottom of the screen, an edge violation occurs which stops the display and interrupts the program. Only STXT must be computed.

An underline symbol is displayed to identify the character in the main text buffer, addressed by the text pointer PNT. When

a light-pen 'see' occurs in the text, the display stops and the program reads the beam coordinates, computes the new pointer position PNT, and updates the text pointer table. This is quite straightforward. Moving the pointer by keyboard commands, however, is rather more involved. The beam position corresponding with a new PNT depends on the number of line-feeds, carriage-returns, tabs, and characters of text between some known beam position (like STXT or an old PNT) and the new PNT, and is not directly available to the program. The method used in the program to find the beam position is to insert a special stopcode into the display table at the new PNT position and update the pointer table only when the display reaches this position and the beam is correctly positioned. The stopcode is then removed and the display tables operated as usual.

### CONCLUSION

The program is intended to be an experiment in display programming rather than one in text editing. Real-time interactions occur between the program and the user, and we should ask whether those interactions are appropriate to scope text editing. The user has two basic methods for communicating with the program; through keyboard and light-pen commands. Selecting a place in the text where an edit function is required 'feels' like a light-pen action, while joining characters to form a text item is surely best done through the keyboard. In fact pointing with the light pen is not a very precise action and it is not easy to hit exactly the desired character in the text. For this reason both keyboard and pen control of the pointer are provided. Mode selection is another action which is not clearly better done one way or the other. Rather it depends on whether the user already has the pen in his hand or is typing something on the keyboard. The program thus accepts mode changes through either pen or keyboard actions. It may be a mistake that the program does not duplicate more controls in this way, possibly all except the fundamental typewriter actions (I and T modes).

An earlier version of the Editor incorporated a very flexible method for scanning through the text by causing it to drift up or down through the window. The method was abandoned because it seemed psychologically unattractive; but it may be worth comment, if only as a warning to future scope editor designers. On entering move mode the program would attempt to reposition the text so that the line containing the pointer was in the middle of the window. This repositioning was repeated every second so that by holding the pointer M lines above or below center with the pen, the text would jump M lines per second down or up through the window. In this mode the pen served as a sort of speed control permitting the rate of drift to be varied from 0 to  $\pm 20$  lines per second. Unfortunately it seemed extremely difficult to read and understand the text when it was being moved continuously in this way; therefore the method was scrapped in favor of the single shift of  $\pm 20$  lines by keyboard selection.

DECUSCOPE is published monthly for Digital Equipment Computer Users Society (DECUS).  
 Material for publication should be sent to: Mrs. Angela J. Cossette, DECUS, Maynard, Massachusetts 01754.  
 Publications Chairman: Joseph Lundy, Inforonics, Inc.  
 Circulation: 1,400 copies per month

Below are short biographies of the candidates for DECUS office. Ballots have been sent to all DECUS Delegates. Results of the election will be announced in November.



## David R. Brown, Guest Speaker at Decus Fall Symposium

Mr. David R. Brown, Manager of the Computer Techniques Laboratory of Stanford Research Institute, will be the featured speaker at the DECUS Fall Symposium to be held at Tresidder Union Hall, Stanford University on November 29. The topic of Mr. Brown's talk is "Computers of the Future--their Logical Design and Implementation."

Mr. Brown is concerned with research in logical design and machine organization, the development of magnetic-logic techniques, and the design and fabrication of digital equipment at SRI. He received a B.S. degree in Electrical Engineering from the University of Washington in 1944 and an M.S. degree in Electrical Engineering from M.I.T. in 1957.

Mr. Brown was a member of the Applied Physics Laboratory of the University of Washington and has worked on the design of the Whirlwind I Computer at the Servomechanisms Laboratory, M.I.T. He was a lecturer in Electrical Engineering at the University of California, where he contributed to the design of the CALDIC (California Digital Computer). In 1951 he returned to M.I.T. to become leader of the Magnetic Materials Group of Lincoln Laboratory, where he was responsible for the development of the ferrite memory core. At Lincoln Laboratory he subsequently became leader of the Advanced Development Group, which designed and built the TX-0 and TX-2 Computers; he was also the head of the SAGE System Office. In 1958 he joined the Mitre Corporation as head of the SAGE System Office. Also at Mitre, he served as the first head of the Component Department, as a member of the ONR Pacific Command Study Group (1959-1960), as head of the Theater Operations Department, and as Associate Technical Director. In the latter capacity, he was responsible for computer and display development, human factors, mathematical techniques, programming research, and operation of Mitre's data-processing facilities.

Mr. Brown is a member of the Institute of Electrical and Electronics Engineers, the IEEE Electronic Computers Committee, and American Standards Association Sectional Committee X-6 (Computers and Related Equipment). He served as Program Chairman of the 1964 Fall Joint Computer Conference, and is a member of the AFIPS Technical Program Committee.

### FOR PRESIDENT

John B. Goodenough

Mr. Goodenough receives his B.A. from Harvard University in Physics in 1961 and an M.A. from Harvard in 1962.

He has been employed by Decision Sciences Laboratory at Hanscom Field, Bedford, Massachusetts since June 1962 as mathematician and systems analyst and has submitted several routines to the PDP-1 DECUS library.

His publications include:

1. "A Lightpen-Controlled Program for Online Data Analysis," Communications of the ACM, February, 1965.
2. With H. Rubenstein, "Statistical Correlates of Synonymy," to appear in Communications of the ACM, late 1965.

He is presently a member of the association for Computing Machinery.

### FOR RECORDING SECRETARY

Eli Glazer

Mr. Glazer received his B.S. in Electrical Engineering at City College of New York in 1957 and a M.S. in Electrical Engineering at Columbus University in 1964.

He was employed at ITT Federal Laboratories from 1957-1961 where his work involved ECM and peripheral equipment. He served in the Signal Corps during 1958-1960 as an Instructor in the Army Ordnance School. He is presently employed at Brookhaven National Laboratories in the Information Processing and High Energy Physics Group. Mr. Glazer is a member of IEEE.

Richard G. Mills

Mr. Mills received his B.S. in both Electrical Engineering and Business and Engineering Administration at M.I.T. in 1954. He received the degree of M.S. in Industrial Management from M.I.T. in 1960. In both his undergraduate and graduate studies, Mr. Mills pursued interests related to digital computer applications, operations research, and quantitative management.

Except for a brief period as a SAC pilot, Mr. Mills' work experience has largely centered around computers. While with the General Electric Company, he worked with mathematical programming applications in production control and scheduling systems. As a part of his graduate work he did research in computer applications and system programming at the M.I.T. Computation Center.

For three years prior to joining Project MAC, Mr. Mills was vice-president of a small computer applications consulting firm in the Boston area. In this association he was involved in advanced computer programming.

Mr. Mills is Assistant Director of Project MAC.

## FOR MEETINGS COMMITTEE CHAIRMAN

Donald A. Molony

At Rutgers University Professor Molony received his B.S. in Mechanical Engineering in 1944, a B.S. in Electrical Engineering in 1947, and a M.S. in 1949. He attended the Technical University, Austria from 1961-1962 on a National Science Foundation Fellowship.

He has been employed as a full-time member of the faculty at Rutgers University (except for military service and while studying abroad) since 1944. Principal areas of activity include electronics, high-frequency engineering, solid state and transistor electronics, computers and computer techniques on both the undergraduate and graduate levels. He has supervised graduate theses in many areas and has been associated with many projects in such areas as: modulation systems, communications systems, microwave electronics, and computer techniques. He has also been responsible for the Computer Laboratory of the Department of Electrical Engineering since its origin.

His publications include:

1. "Moment Detection and Coding," Communication and Electronics, July, 1957.
2. "Moment Detection and Coding," Electrical Engineering, June, 1957.
3. "Electronically Tunable Selective Amplifier for Format Synthesis," Journal of the Acoustical Society of America, July, 1956.
4. "Detection of Information by Moments," I.R.E. Convention Record, March, 1953.
5. More than 50 progress and technical reports submitted to various government agencies.

## PROGRAMMING NOTES

### KRIEGSPIEL CHESS - A DEMONSTRATION PROGRAM

Michael S. Wolfberg,  
Moore School of Electrical Engineering,  
University of Pennsylvania

Kriegspiel Chess is a variation of the classical game of chess, where the two players sit back to back. Each player has his own chessboard on which he has only his own chessmen. He does not know positively where his opponent's men are positioned. A third person, the arbiter, looks over the players' shoulders and supplies enough information to the players so that they can play a legal game of chess. The arbiter gives a bit more information beyond whether the players are making legal moves, but not very much. When White attempts a move, the arbiter announces either "White moved" or "No," depending on whether the move is legal, and the same for Black. Once a player makes a move which the arbiter has recognized as legal, the player may not retract it.

The arbiter also announces when one of the players has made a capture, which is often a surprise to both players. The

player who made the capture does not know what piece he captured, and the player whose piece was captured does not know what piece did the capturing. The arbiter announces the square on the board where the capture was made. When one of the players moves, putting his opponent's king into check, the arbiter announces how the checking is accomplished. The only information the arbiter discloses is checking one or two of the following:

1. Along a rank (row)
2. Along a file (column)
3. Along the king's short diagonal
4. Along the king's long diagonal
5. By a knight

To understand the meaning of 3. and 4., note that each square on the chessboard is a member of two diagonals. The lengths of these are never the same, and there is a Short and a Long diagonal for every square. The corner squares have diagonals of lengths 0 and 8.

In order to give a little more information to players, the arbiter announces one more indication of the position. When it is White's turn to move, the arbiter announces the number of pawn moves which White may legally make which will capture a Black piece. The arbiter does this by announcing that White has  $x$  tries, and the same for Black. This game is otherwise played like classical chess until a checkmate is reached. To add to the confusion, the arbiter conceals the fact that there is a checkmate or stalemate, since the player to move can deduce this after trying all possible moves.

PDP-5--Teleregister Kriegspiel - For the purposes of demonstration, the PDP-5 has been programmed to arbitrate a Kriegspiel Chess game played by two players, each at a Teleregister display console. The consoles are separated so that neither player may see the other's display screen. A Teleprinter in a corner of the room records all the moves being made by both players so that when the game is over, it can be replayed, often the most enjoyable phase of Kriegspiel. The players find out what moves they missed, what they could have done "if they had only known."

When the game begins, the initial board positions are displayed on the consoles, along with the message: "WHITE BEGINS." The player White then keys in his move in Descriptive Chess Notation e.g., P5-K4 or N2-KB3. If the move is legal, a message is sent to both consoles, and White's board is updated according to his move. The game continues until the players deduce a checkmate or stalemate, or decide the game is a draw. In order to initialize a new game, both players must key in: "END."

During the course of a game if a player wants to mark a square on his board not occupied by one of his own men, he may key in "[" followed by the name of the square, immediately followed by the single character for marking. If no character is given, any marking character which was at the square is removed.

The notation for castling is: o-o for king side and o-o-o for queen side (note--the letter "o" is used).

In pawn promotion, the notation is, for example, P8-KR8(Q), where the single character in parentheses is either Q, R, B, or N. If nothing follows the move, "(Q)" is assumed.



# 340 DISPLAY PROGRAMMING: MODIFICATION OF THE SYMBOLIC ASSEMBLER PERMANENT SYMBOL TABLE

Sanford Adler

System Sciences Laboratory, New York University

The following mnemonics have been developed for use on a PDP-7 Computer equipped with the following display hardware:

340 Display (light pen, character generator, subroutine option)

343 Slave Display (light pen)

1. To specify the Mode of the next word in the display table

Mode	Symbol	Octal Code
Parameter	PAR	000000
Point	PT	020000
Slave	SLV	040000
Character	CHR	060000
Vector	VCT	100000
Vector Continue	VCTC	120000
Increment	INCR	140000
Subroutine	SUBR	160000

2. Parameter Mode Words

Scale Settings	S0	100
	S1	120
	S2	140
	S3	160

Intensity Settings	IN0	10
	IN1	11
	IN2	12
	IN3	13
	IN4	14
	IN5	15
	IN6	16
	IN7	17

STOP STP 3000

Light Pen On LPON 14000  
Light Pen Off LPOFF 10000

3. Point Mode Words

Vertical Word	V	200000
Horizontal Word	H	000000
Intensify Point	IP	2000

4. Slave Mode Words

Slave 1 On	S1ON	5000
Slave 1 Off	S1OFF	4000
Light Pen 1 On	LP1ON	2000

Slave 2 On	S2ON	500
Slave 2 Off	S2OFF	400
Light Pen 2 On	LP2ON	200

5. Character Mode Words

We are presently considering the addition of a subroutine to

the Editor Program which would convert characters typed on the TT into the character generator code and assemble them three per word in a display table. With such a subroutine, the text typed by the user would appear on the display in exactly the same way as it was typed.

6. Vector and Vector Continue Mode Words

Escape*	ESCP	400000
Intensify*	INSFY	200000

\*\* (See notes at the end of this article.)

7. Increment Mode Words

Move First Point	Right	P1R	100000
	Left	P1L	140000
	Up	P1U	020000
	Down	P1D	030000
	Up & Left	P1UL	160000
	Up & Right	P1UR	120000
	Down & Left	P1DL	170000
	Down & Right	P1DR	130000

Move Second Point	Right	P2R	4000
	Left	P2L	6000
	Up	P2U	1000
	Down	P2D	1400
	Up & Left	P2UL	7000
	Up & Right	P2UR	5000
	Down & Left	P2DL	7100
	Down & Right	P2DR	5100

Move Third Point	Right	P3R	200
	Left	P3L	300
	Up	P3U	040
	Down	P3D	060
	Up & Left	P3UL	340
	Up & Right	P3UR	240
	Down & Left	P3DL	360
	Down & Right	P3DR	260

Move Fourth Point	Right	P4R	10
	Left	P4L	14
	Up	P4U	02
	Down	P4D	03
	Up & Left	P4UL	16
	Up & Right	P4UR	12
	Down & Left	P4DL	17
	Down & Right	P4DR	13

Escape*	ESCP	400000
Intensify*	INSFY	200000

8. Subroutine Mode Words

Display Deposit Save Register	DDS	200000
Display Jump	DJP	400000
Display Jump and Save	DJS	600000

The octal codes can be used directly by the programmer to form in octal the specific word format he requires. This can be done without adding the mnemonics to the Assembler Permanent Symbol Table.

\*The codes are the same for vector, vector continue, and

increment modes. Note that intensification in point mode has a different code.

\*\*The following addition to this table was suggested by a DEC programmer. It would be inserted in the section indicated by two asterisks.

dy1 = 400  
dy2 = 1000  
dy4 = 2000  
dy8 = 4000  
dy16 = 10000  
dy32 = 20000  
dy64 = 40000  
  
my = 100000  
mx = 200

## DECUS PROGRAM LIBRARY

### PDP-1 PROGRAM LIBRARY ADDITIONS

#### DECUS NO. 7A

Title: Modified Expensive Typewriter (Macro)

Authors: Sheldon B. Michaels, John L. Ramsey, AFCRL

This program is intended to make both off-line and on-line editing of symbolic tapes more rapid and flexible than with "Circular" (MIT-2) Expensive Typewriter. To accomplish this, a number of control characters have been added or modified.

1. Six new control characters have been added to the Expensive Typewriter (henceforth abbreviated E.T.). All the old features remain.

a. The (z) control character allows an off-line prepared symbolic correction tape to be read in, thus reducing on-line time requirements to an absolute minimum.

b. The (-) (overstrike) control character enables the user to specify desired lines by symbols rather than by line numbers. This makes possible the preparation of the off-line correction tape without the necessity of counting lines.

c. The ( ) control character enables the user to find all lines of text which contain user-specified character sequence.

d. The (b) and (h) control characters allow specification of the number of registers occupied by the text buffer. This program can use two cores if desired, allowing for storage of over 20,000 characters.

e. The (u) control characters allow the buffer to be restored after it has been killed.

To return from text mode to control mode, SENSE switch is no longer needed.

3. Two changes have been made in the internal logic.

4. The (p) control character has been modified to allow the user to punch desired sections of his text.

#### DECUS NO. 83

Title: 340 Assembly Language and 340-DDT

Author: John B. Goodenough, ESD, Hanscom Field

This program resembles ordinary DDT in that it allows the bit patterns of the 340 Scope instructions to be inspected and changed, on-line, in a symbolic language. The symbols used are identical to the symbols used when compiling programs for the scope.

In addition registers may be inspected and changed using ordinary machine language.

The action operator tape, which defines the 340 Assembly Language, can be compiled only with the 2-core DECAL of November 1964 (or with versions of DECAL derived from the Skeletal DECAL of November 1964). After compilation, DECAL can be punched off to obtain a permanent copy of DECAL with the 340 definitions.

Following the action operators is a test program which can be compiled and loaded to check that the compiler is using the definitions correctly. The pattern produced by the test program is described in the 340 DDT write-up.

NOTE: The 340 DDT program only resembles DDT; it is not a modification of regular DDT.

#### DECUS NO. 84

Title: M.I.T. Floating Point Arithmetic Package

Authors: B. Gosper, T. Eggers

The Floating Package is a group of arithmetic subroutines in which numbers are represented in the form  $f \times 2^e$ .  $f$  is a 1's complement 18-bit fraction with the binary point between bits 0 and 1.  $e$  is a 1's complement 18-bit integer exponent of 2. The largest magnitude numbers that can be represented are  $\approx 10^{39},000$ .

A number is normalized when  $1/2 \leq |f| < 1$ . All the floating point routines, except the two floating unnormalized adds, return a normalized answer. The fraction appears in the AC, the exponent in the IO. Routines include:

Floating Add - JDA FAD

Floating Multiply - JDA FMP

Floating Divide - JDA FDV

Floating Square Root - JDA FSQ

Floating Log, base 2 - JDA LOG

Floating Reciprocal - JDA RCP

Floating Input - JDA FIP

Floating Output - JDA FOP

Floating Unnormalized Add - JDA FUA

Floating Unnormalized Add and Round - JDA FUR

Floating Exponentiation - JDA F2X

## DECUS NO. 85

Title: LISP for the PDP-1

Authors: L. Peter Deutsch and Edmund C. Berkeley

LISP (for LISP Processing) is a language designed primarily for processing data consisting of lists of symbols. It has been used for symbolic calculations in differential and integral calculus, electrical circuit theory, mathematical logic, game playing, and other fields of intelligent handling of symbols.

LISP for the PDP-1 uses, from the basic functions, about 1500 registers, and for working storage from about 500 to 14000 registers (the latter in a four-core PDP-1) as may be chosen. It is flexible, permits much investigation, and the correction of preliminary expressions.

## PDP-5 PROGRAM LIBRARY ADDITIONS

### DECUS NO. 5-24

Title: Vector Input/Edit

Authors: R. Rubinoff, D. Goelman, and J. Flomenhoft, Moore School of Electrical Engineering, University of Pennsylvania.

This program accepts Teletype and effects editing options by implementing a man-machine dialogue. Development of the program was supported, in part, by the Air Force Office of Scientific Research and the Army Research Office.

### DECUS NO. 5-25

Title: A Pseudo Random Number Generator for the PDP-5 Computer

Author: P.T. Brady, New York University

The random number generator subroutine, when called repeatedly, will return a sequence of 12-bit numbers which, though deterministic, appears to be drawn from a random sequence uniform over the interval 0000g to 7777g. Successive numbers will be found to be statistically uncorrelated. The sequence will not repeat itself until it has been called over 4 billion times.

The program tape is prefixed with a text for a relocatable loader, used at NYU, but this may be bypassed and the binary section will then read directly into 3000-3077.

## PDP-7 PROGRAM LIBRARY ADDITIONS

### DECUS NO. 7-7

Title: INPUT ND 180, INFLT ND 180, INPUT VICTOREEN, and INFLT VICTOREEN

Author: Philip Bevington, Stanford University

These are four FORTRAN subroutines for the PDP-7 which read punched paper tapes of data from nuclear data multichannel pulse-height analyzers and store them in fixed or floating point arrays. These subroutines are in mixed FORTRAN and PDP-4/7 symbolic languages and utilize EAE instructions.

## DECUS NO. 7-8

Title: FPTSCOPE, FPTPEN, and FPTPLOT

Author: Philip Bevington, Stanford University

FPTSCOPE, FPTPEN, and FPTPLOT are three FORTRAN subroutines for the PDP-7 which provide oscilloscope display and X-Y plots of single parameter spectra using the Type 34 Display. These subroutines are similar to PTSCOPE, PTPEN, and PTPLOT, (rev. 8/65) but display spectra stored in floating point mode.

## COMPUTER OPTIONS

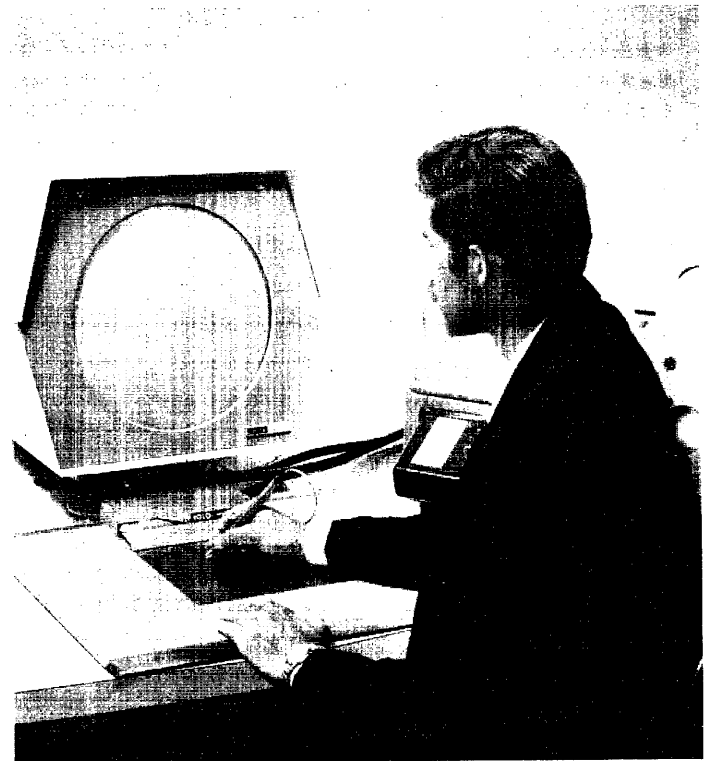

### GRAFACON

The GRAFACON Model 1010 is a low-cost advanced graphical input system produced by Data Equipment Company, Division of BBN Corporation, Santa Ana, California. The first all-digital, solid-state system of its kind for general purpose digital computers, the Model 1010 is based upon the Rand Tablet; it is expected to permit greater freedom of expression in direct man-machine communication than heretofore possible.

#### The System

The GRAFACON Model 1010 consists of a "writing surface", an "electronic pen", and associated control electronics. The writing surface is actually a unique printed-circuit screen. It has a 10 x 10-inch area, and will provide 100 lines per inch resolution in both the x and y axes. The electronic pen picks up pulses from the screen, amplifies them, and sends them to the electronics package for translation into computer language. Transmission of these data to the computer is then accomplished through special interface circuitry.

Description of the system is best illustrated by reference to the general block diagram. Information flow paths are indicated by the heavier lines. The clock sequencer furnishes a time sequence of 20 pulses to the blocking oscillators, during which they give coincident positive and negative pulses on two lines attached to the tablet.

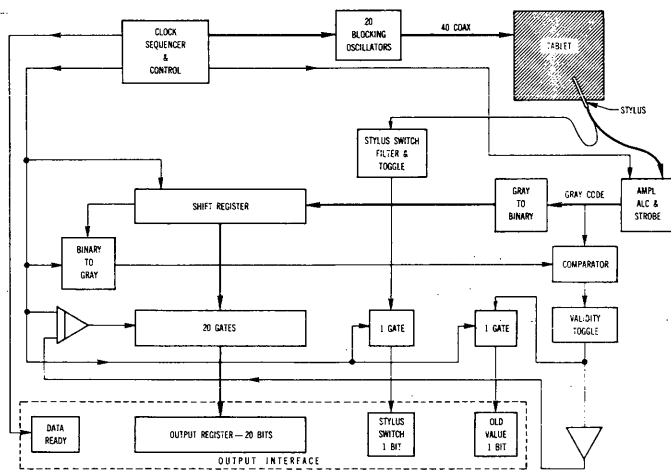

The pulses are encoded by the tables as serial  $x, y$  Gray-code position information which is sensed by the high-input impedance, pen-like stylus from the epoxy-coated tablet surface. This information is strobed, converted from Gray to binary code, assembled in a shift register, and gated in parallel to an interface register.

The Gray code was selected so that only one bit would change value with each wire position, giving a complete and unambiguous determination of the stylus position. Further, Gray code facilitates serial conversion to binary.

The printed-circuit, all-digital tablet, complete with printed-circuit encoding, is a new concept, and is the heart of the graphic input system. The basic building material is 0.5-mil-thick Mylar sheet, clad on both sides with 1/2 ounce copper (approximately 0.6 mils thick) and etched. The result is a printed circuit on each side of the Mylar, each side in proper registration with the other.

The top circuit contains the  $x$  position lines and  $y$  encoder sections, while the bottom circuit has the  $y$  position lines and  $x$  encoder sections. Position lines are connected at the ends to wide, code-coupling buses; these buses are as wide as possible in order to obtain the maximum area, since the encoding method depends on capacitive coupling from the encoder sections through the Mylar to these buses. The position lines are alternately connected to wide buses on opposite ends, giving symmetry to the tablet and minimizing the effect of registration errors.

The stylus placed anywhere on the tablet will pick up a time sequence of pulses, indicating the  $x, y$  position. This detected pulse pattern will repeat itself every major cycle as long as the stylus is held in this position. As the stylus is moved, a different pulse pattern is sensed, indicating a new position. Since there are 1024  $x$  position lines and 1024  $y$  position lines, 20 bits are required to define a point.

The final stages of the amplification and the strobing circuit are dc-coupled, and the system is thus vulnerable to shift in the dc signal level. An automatic level control (ALC) circuit has been provided to ensure maximum recognizability of signals. During the first 180  $\mu$ sec of a major cycle, the stylus

is picking up bits from the tablet. During the last 40  $\mu$ sec the tablet is at its quiescent level, and the quiescent level of the pen is strobed into the ALC toggle. In a perfectly balanced system, the ALC toggle alternates between 1 and 0 with each major cycle.

As an  $x, y$  value is being converted to binary and shifted into one end of the shift register, the old binary value is being shifted out the other end, serially reconverted to Gray and compared to the incoming Gray value, one bit at a time. If the old Gray number and incoming gray number differ in more than one bit in either  $x$  or  $y$ , a "validity" toggle is set to indicate an error, that the pen has moved more than one line during the 220- $\mu$ sec interval.

The system finds application in a wide range of fields now utilizing digital computers extensively as a means of research, production data processing, and graphical data reduction.

#### Programming Note

By: Russ Winslow, DEC

When writing programs intended to operate on both the PDP-5 and 8, the following routine will prove useful in allowing the program to determine in which machine it is running.

```
isz 0
skp
isz 0
. /PDP-8
. /PDP-5
```

## NEWS ITEMS

### Foxboro Company Purchases Six PDPs For Digital Process Control Systems

The Foxboro Company's Digital Systems Division of Natick, Mass., has purchased six central processors and peripheral equipment for use in Foxboro's Model 97000 Digital Industrial Process Control Systems.

The processors, designed and built by Digital to specifications drawn by Foxboro, are functionally equivalent to Digital's general-purpose PDP computers but with a more extensive input/output system built by Foxboro to meet specific needs of real-time industrial process control.

They are being used in systems built by Foxboro for the Board of Public Utilities in Kansas City, Kans., to log data; the Central Electric Power Cooperative of Conway, S.C., to log data; Associated Electric Cooperative of Thomas Hill, Mo., to log data and calculate results and efficiency; Chase Brass & Copper Company of Montpelier, Ind., to perform inventory control and other business applications in addition to casting control; and Allegheny Power System's Fort Martin Station in Fairmont, W.V., to log data and calculate results and efficiency.

Earlier control systems built by Foxboro around processors supplied by Digital are at United States Steel Company's Homestead Mill, controlling a blast furnace; at National Biscuit Company's Chicago bakery, controlling batch processing; at Dow Chemical Company, Midland, Mich., direct digital control installation; at the mill of Wheeling Steel Corporation

in Wheeling, W.V., controlling a basic oxygen process; at Esso Research Company, another direct digital control installation controlling a refinery; at Penn-Dixie Cement Company's Petoskey, Mich., installation monitoring a cement kiln; and at a Puerto Rico Power Resources Authority's generating station, controlling two 100-megawatt steam turbine units.

#### Bermuda Press Installs Island's First Computer

The first computer for commercial use in Bermuda has been installed at the Bermuda Press Limited of Hamilton, which publishes the island's two daily newspapers and operates a job printing shop.

Bermuda Press will use the PDP-8 Typesetting System for a variety of jobs in addition to its basic composing room assignment. Initial plans call for the system to set all the straight text matter in the newspapers, both news and classified advertisements. In the typesetting job, the computer

accepts tapes punched by noncounting perforators and generates a clean tape to drive automatic linecasting machines. The shop uses three linecasters regularly and has a fourth standing by. News holes in the newspapers, the Royal Gazette and Mid-Ocean Daily News, range from 50 to 100 columns. The Gazette, with a weekday circulation of 8,700, is published seven mornings a week. The News, published Monday through Thursday and Saturday afternoons, has a Saturday circulation of 10,000. The program to perform the typesetting function is part of the system package supplied by DEC. The program facilitates the use by the operator of type faces and styles for needs in the news, editorial, and advertising pages.

Additional programs being developed by Bermuda Press would permit the computer to call in from auxiliary storage devices programs to perform the other data processing jobs being considered for the computer. Coding characters at the start of each raw tape will call in whatever program is needed to set the contents of the tape.

## NEW DECUS MEMBERS

#### PDP-1 DELEGATES

Charles J. Harmon  
Aerospace Medical Research Laboratory  
Wright-Patterson AFB, Ohio

Adrian C. Mellissinos  
The University of Rochester  
Rochester, New York

#### PDP-5 DELEGATE

Mr. Robert Berger  
will replace Mr. J. Meltzer  
Bell Telephone Laboratories, Inc.  
New York, New York

#### PDP-7 DELEGATES

Martin L. Cramer  
Electronic Associates Inc.  
Princeton, New Jersey

Donald Hodges  
Argonne National Laboratory  
Argonne, Illinois

M. D. Woolsey  
The University of Tennessee  
Memphis, Tennessee

#### PDP-8 DELEGATES

Bruce Biavati  
Columbia University  
New York, New York

Leonard P. Goodstein  
Danish Atomic Energy Commission  
Roskilde, Denmark

Henry P. Kilroy  
Potter Instrument Company, Inc.  
Plainview, New York

Kai Smith  
AGA AKTIEBOLAG  
Lidingo Sweden

Robert Vonderohe  
Argonne National Laboratory  
Argonne, Illinois

#### INDIVIDUAL MEMBERS

Lawrence Amiot  
Argonne National Laboratory  
Argonne, Illinois

James H. Bennett  
Applied Logic Corporation  
Princeton, New Jersey

Joel C. Berlinghieri  
The University of Rochester  
Rochester, New York

L. R. Bowyer  
Bell Telephone Laboratories, Inc.  
Holmdel, New Jersey

Daniel A. Brody  
The University of Tennessee  
Memphis, Tennessee

Thomas V. Brown  
New York University  
Bronx, New York

H. J. Christensen  
A.E.K. Research Establishment  
Riso, Denmark

William S. Cook  
Applied Data Research, Inc.  
Princeton, New Jersey

Laurice Fleck  
M.I.T. Lincoln Laboratory  
Lexington, Massachusetts

Mary Flesher  
M.I.T. Lincoln Laboratory  
Lexington, Massachusetts

John W. Frazier  
Aerospace Medical Research Labs.  
Wright-Patterson AFB, Ohio

Gary B. Guardineer  
Brookhaven National Laboratories  
Upton, New York

Howard C. Johnson  
Bell Telephone Laboratories, Inc.  
Holmdel, New Jersey

Robert J. Kolker  
M.I.T. Lincoln Laboratory  
Lexington, Massachusetts

David B. Loveman III  
Applied Logic Corporation  
Princeton, New Jersey

K. C. Turberfield  
A.E.R.E. Harwell  
Berkshire, England

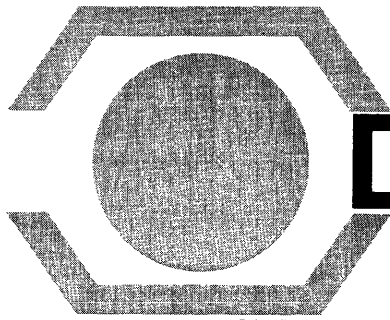

# DECUSCOPE

DIGITAL EQUIPMENT COMPUTER USERS SOCIETY

MAYNARD, MASSACHUSETTS / TEL. 897-8821 / TWX 710 347-0212

OCTOBER 1965

Vol. 4 No. 10

## DECUS FALL SYMPOSIUM

Tresidder Union Hall, Stanford University

November 29, 1965

### AGENDA

- 8:30-9:30 Registration and Coffee
- 9:35 Opening of Meeting  
William A. Fahle, DECUS President  
John T. Gilmore, Jr., DECUS Meetings Chairman
- 9:45 Welcome Address  
Philip Bevington, Professor, Stanford University
- 10:00 Computers of the Future - Their Logical Design and Implementation  
David R. Brown, Guest Speaker
- 10:45 Morning Session A or B

#### SESSION A- EXPERIMENTS, APPLICATIONS

- 10:45 The PDP-1 Program GRASP  
Ronald Gocht, Stuart Sharpe, United Aircraft Research Laboratories
- 11:15 Direct Digital Control to High Energy Particle Accelerators  
Donald R. Machen, Lawrence Radiation Laboratory (Berkeley)
- 11:45 Current Trends in Hybrid Computer Oriented Software  
Stephen F. Lundstrom, Consultant to Applied Dynamics Inc.

#### SESSION B-GENERAL AND UTILITY

- 10:45 A.L.I.C.S. - Assembly Language  
Joseph A. Rodnite, Information Control Systems
- 11:15 Some New Developments in the DECAL Compiler  
Richard McQuillin, Inforonics Inc.
- 11:45 Message Switching System Using the PDP-5  
Sypko Andrae, Lawrence Radiation Laboratory (Berkeley)
- 12:15-1:00 Lunch
- 1:15 Afternoon Session A or B

#### SESSION A- EXPERIMENTS, APPLICATIONS

- 1:15 Spiral Reader Control and Data Acquisition with the PDP-4  
Jon D. Stedman, Lawrence Radiation Laboratory (Berkeley)
- 1:45 PARAMET - A program for the Visual Investigation of Parametric Equations  
Kenneth R. Bertram, Lawrence Radiation Laboratory (Livermore)
- 2:15 Coffee
- 2:30 On-Line Reduction of Nuclear Physics Data with the PDP-7  
Philip Bevington, Stanford University
- 3:00 Application of the LINC  
Alan Boneau, Duke University

#### SESSION B-GENERAL AND UTILITY

- 1:15 The Learning Research and Development Center's Computer Assisted Laboratory  
Ronald G. Ragsdale, University of Pittsburgh
- 1:45 Time-Sharing the PDP-6  
Thomas N. Hastings, Digital Equipment Corporation
- 2:15 Coffee
- 2:30 A Data Acquisition System for Submarine Weapons System Evaluation Utilizing a PDP-8  
Robert H. Bowerman, U.S. Naval Underwater Ordnance Station
- 3:00 Plant Wide Computer Capability (PDP-5)  
James Miller, Dow Badische
- 3:30-5:00 Tours  
Stanford Computation Center - PDP-1 Time-Sharing  
Stanford SCANS System and Medical Center - PDP-7, -8, and LINC  
SLAC - Stanford Linear Accelerator Center
- 4:30 DECUS Delegates Meeting
- 5:30 Cocktails and Dinner at Ricky's Hyatt House, Palo Alto

## COMPUTERS OF THE FUTURE - THEIR LOGICAL DESIGN AND IMPLEMENTATION

David R. Brown  
Stanford Research Institute  
Menlo Park, California

Advances in microelectronics call for new methods of logical design. These advances, such as integrated semiconductor circuits, permit fabrication of complex networks in a single process where many circuit elements and their interconnections are made simultaneously during steps of the process. Lower cost and higher reliability will result (hence more sophisticated systems), but the building blocks will no longer be the convenient gate or flip-flop. Circuit speed will also improve, tending to decentralize control and to merge control, storage, and logic. Consequently, the logical design will have to be better coordinated with the manufacturing process and the design of system software.

### THE PDP-1 PROGRAM GRASP

R. Gocht, S. Sharpe  
United Aircraft Research Laboratories  
East Hartford, Connecticut

GRASP is a general purpose PDP-1 digital computer program. It uses the Digital Equipment Corporation's Type 340 Scope Display to provide effective and direct graphical communication between a problem in the computer and the operator. This Graphics Assisted Simulation Program gives the "simulation" user even more versatile problem control than would an analog computer. The generality of GRASP allows it to accommodate many different types of problems with unique input-output control requirements. All solutions are displayed in graphical form on the scope. Variation of problem parameters and input data, including arbitrary function generation, is accomplished under light pen control. A short example is used to illustrate the general method of GRASP operation.

### DIRECT DIGITAL CONTROL TO HIGH ENERGY PARTICLE ACCELERATORS

Donald R. Machen  
Lawrence Radiation Laboratory  
Berkeley, California

The Bevatron, at the Lawrence Radiation Laboratory in Berkeley, exhibits many of the unmistakable characteristics of a multivariable process. Automatic control of machine parameters is of major interest to not only the operating management but experimental physics groups as well.

In order to fully explore the possibilities of stored program digital computer control in the accelerator field, a PDP-5 computer, together with the necessary interface, telemetry channels, and remote sense logic, is being installed at the Bevatron.

Closed-loop automatic control of beam position and intensity between the linear accelerator and the main accelerating ring will be accomplished through the PDP-5.

## CURRENT TRENDS IN HYBRID COMPUTER ORIENTED SOFTWARE

Stephen F. Lundstrom  
Consultant to Applied Dynamics Inc.  
Ann Arbor, Michigan

Many interpreters and compilers have been developed recently to assist the engineer in the complex job of programming a hybrid computer problem. After a short discussion of the hardware involved in hybrid computers and some of the unique problems therein; discussion centers on the functions of some of the more outstanding representatives of the current software developments.

Some of the software developments discussed include SPOUSE, MAID, TAOIST, AND FOCHUS. The interpreter portion of SPOUSE (Stored Program OUtput Setup Equipment) is designed to assist the engineer in the setup and check-out of the analog subsystem. The MAID software package is used by engineers and technicians in the automatic diagnostic check-out of the analog subsystem. TAOIST, a program originally developed for a 12K core PDP-8, is an aid to the engineer in the initial phases of hybrid and analog computer problem solution. It accepts a description of the problem in mathematical terms and provides the engineer with a list of all problem variables, coefficients, scaling factors, and other useful information. Upon assignment of analog equipment, the program will automatically do all static check-out of every analog component used in the analog subsystem. The last main point of discussion is the FOCHUS (FORtran Compiler for Hybrid USers) program. This is a compiler designed to accept FORTRAN code, but also to be useful to the engineer in the solution of hybrid problems since a fairly close control over communication between the analog and digital subsystems is allowed.

The paper concludes with some short mention of possible future uses, modifications, and developments in software.

### A.L.I.C.S. --- ASSEMBLY LANGUAGE BY INFORMATION CONTROL SYSTEMS

Joseph A. Rodnite  
Information Control Systems, Inc.  
Ann Arbor, Michigan

This paper describes the algorithms for the development and implementation of an assembly language for the PDP-5/8 which makes the machine appear to the user to have every core location directly addressable. Since all of the book-keeping is done by the assembler, relocation becomes practical. A special relocatable loader which allows subroutine relocation is also described.

For the first time it becomes practical for a user to build up a library of binary subroutines and to load them as needed. This feature alone justifies the development and use of the new language. The syntax of the new assembly language is similar to PAL, so there will be little if any difficulty in making existing routines relocatable.

## SOME NEW DEVELOPMENTS IN THE DECAL COMPILER

Richard J. McQuillin  
Inforonics Inc.  
Maynard, Massachusetts

This paper describes work being carried on by the author for the Decision Sciences Laboratory, ESD, as well as other work that has recently been completed on the development of DECAL.

The basic 1-core version of DECAL was released in its present form as DECAL-BBN in September, 1963. Since that time there has been a general increase in memory capacity of many PDP-1's, and DECAL has likewise been expanding. The first development was the moving of the compiler's symbol table into the second core field. This allowed large programs with many symbols to be compiled. Next came a 2-core modification to allow the compilation to be carried out in sequence break mode. This doubled the speed of compilation. Recently there has been a further modification to compile programs written in ASCII source language.

The author has been carrying on work to extend the DECAL language. In particular the work has been in the area of allowing real (floating point) variables and constants to be handled automatically in algebraic statements. The other area of work has been to implement input/output facilities in the DECAL language. This has led to the development of a language similar to the FORTRAN input, output, and format statements.

Finally the author will discuss the desirability of implementation of DECAL on the other PDP computers. DECAL has been developed into a powerful and elegant language through many man-years of effort. Perhaps consideration should be given to other machines, specifically the PDP-6 and PDP-7.

## MESSAGE SWITCHING SYSTEM USING THE PDP-5

Sypko W. Andreae  
Lawrence Radiation Laboratory  
Berkeley, California

At the Center for Research of Management Science at the University of California, Berkeley, recently a message switching system was constructed which is used for research of human behavior in game situations.

The system uses a PDP-5, a 630 System with ten Teletypes, a DEC tape unit, and an IBM compatible tape unit. The basic Laboratory layout entails many soundproof rooms in each of which the subject can use one of the Teletypes. The controlling program is essentially a simple time-sharing system of which the organization is outlined in this Paper. Among the many advantages of the existing system over the previous manual method are improved traffic intensity, better record keeping, network control by the experimenters, etc.

Two examples of games used in these experiments are given.

## SPIRAL READER CONTROL AND DATA ACQUISITION WITH PDP-4

Jon D. Stedman  
Lawrence Radiation Laboratory  
Berkeley, California

The spiral reader is a semiautomatic, film-digitizing machine that is used by the Alvarez Physics Group at the Lawrence Radiation Laboratory to measure photographs of elementary nuclear particle interactions which are created in a hydrogen bubble chamber. This man-machine-computer system has been measuring these event interactions at an average rate of 75 per hour. As well as being the fastest overall measuring system in operation, it has proven to be highly reliable and easy to maintain.

This system incorporates several unique features that contribute to its efficient operation and high processing rate. A PDP-4 computer controls the following functions: procedure sequencing, data acquisition, data conversion and validity checking, data display, machine diagnostics, machine control, and reaction feedback to human interventions. The operations performed by the spiral reader are: digitizing the event on the film, digitizing the fiducial marks, advancing the film frames, and responding to human control of its event centering stage via the "speed ball." Finally, and the most important part of the system is the human operator who is relied upon to monitor and control the other two parts by looking at the data display CRT, reading the indicative and diagnostic messages from the Teletype, verifying the automatic film frame position using the control button, recognizing and centering on events by means of the "speed ball" finger control, and giving measure commands with a control button. This balanced combination of man and machine has proven to be an excellent impedance match with the other analysis procedures encountered in experimental bubble chamber physics.

## ON-LINE REDUCTION OF NUCLEAR PHYSICS DATA WITH THE PDP-7\*

Philip R. Bevington  
Department of Physics, Stanford University  
Stanford, California

In the continuing debate over the relative merits of fixed-wire analyzers vs. computer systems for the acquisition of nuclear physics data, the PDP-7 has emerged as an excellent compromise between cost and capability. The advantages inherent in a computer system are illustrated with specific ways in which the Stanford Computer for the Analysis of Nuclear Structure (SCANS) is used to reduce, point-by-point, on-line data from nuclear physics experiments, as well as to analyze such data with real-time control. Specifically, programs to identify and sort charged particles with thick (E) and thin (dE/dx) solid state detectors, to stabilize the scale of pulse-height spectra, and to control the acquisition of two-parameter data are discussed. The dead time contributed by these programs is shown to be negligible. The equally important ability to control the subsequent analysis of these data in real-time is also discussed with reference to the methods adopted by SCANS to accept, record, and display the data.

\*Sponsored in part by the National Science Foundation.



## PARAMET - A PROGRAM FOR THE VISUAL INVESTIGATION OF PARAMETRIC EQUATIONS.\*

Kenneth R. Bertram  
Lawrence Radiation Laboratory  
Livermore, California

Paramet is an operator oriented program which accepts parametric equations from a typewriter and produces a graphical presentation on a CRT. Equations are of the form  $x = f_1(t)$ ,  $y = f_2(t)$ ; where  $f_i(t)$  is any combination of the operations available (i.e., addition, subtraction, multiplication, division, exponentiation, logarithm, sine, and cosine). After the equation is initially entered from the typewriter, control is transferred to the light pen. With the light pen the operator can change the values of the various constants which have been used in the equations. He can also control operations such as scaling, tape storage, and retrieval.

Paramet provides a convenient method of finding first approximations in curve fitting. The investigation of particular equations is readily pursued. As an educational tool, Paramet provides the student with a feeling for his subject more effectively than conventional methods.

\*Work performed under the auspices of the U.S. Atomic Energy Commission.

## APPLICATION OF THE LINC

Alan Boneau  
Duke University  
Temporarily Studying at Stanford University  
Stanford, California

Operant conditioning is a procedure in which selected behavior of individual organisms is controlled by a judicious choice of reward contingencies. This paper describes some of the work of the three psychologists in the LINC Evaluation Program and how they adapted LINC to their operant conditioning projects. The use of the computer in dealing with temporal response variables will be highlighted.

## THE LEARNING RESEARCH AND DEVELOPMENT CENTER'S COMPUTER ASSISTED LABORATORY

Ronald G. Ragsdale  
University of Pittsburgh  
Pittsburgh, Pennsylvania

This paper describes the operation and planned applications of a computer-assisted laboratory for social science research. The laboratory centers around an 8K PDP-7 and its special peripheral equipment, with most of the system already in operation. Special devices include random-access audio and video, graphical input, touch-sensitive and block-manipulation inputs. The control programs for these devices are incorporated in an executive system which permits simultaneous operation of six student stations. The system may be used for presenting instructional material or for conducting psychological experiments.

## TIME SHARING THE PDP-6

Thomas N. Hastings  
Digital Equipment Corporation  
Maynard, Massachusetts

The PDP-6 time-sharing effort has been undertaken in two

distinct phases. The first phase is a multiprogramming system in which all programs are resident in core and are controlled by users at Teletype consoles. Up to 256K of memory may be used with I/O devices which include a card reader, a line printer, 8 IBM compatible magnetic tapes, 8 addressable magnetic tapes (DECtapes), a paper tape reader, a paper punch, and up to 64 Teletypes. The addressable DECtapes permit storage and retrieval of programs and data by file name. All I/O operation is overlapped with computation first for the user program requesting the input-output, and secondly, for other user programs. In this way, the central processor and the I/O devices are kept as busy as possible. All user programs run relocated and protected from each other. Nine phase-one systems have been in operation in the field since May, 1965.

The second phase extends the multiprogramming capabilities by providing a fast secondary storage device for program swapping by the monitor. Thus, more user programs may be run simultaneously that can fit into core at the same time. This I/O device is also available for storage of user programs and data. Since device independence will be maintained, user programs will not need to be modified to make use of the phase-two system.

## A DATA ACQUISITION SYSTEM FOR SUBMARINE WEAPONS SYSTEM EVALUATION UTILIZING A PDP-8

Robert H. Bowerman  
U.S. Naval Underwater Ordnance Station  
Newport, Rhode Island

This paper traces the data recording system requirements for shipboard weapons system tests in terms of increased complexity. A newly designed system, presently under procurement, is described in terms of the above requirements and also with regard to PDP-8 hardware utilized. In addition to the basic computer and magnetic tape system (repackaged for portability and environmental protection), there is a high-speed 20-character line printer and a set of multiplexed synchro-to-digital, and voltage-to-digital conversion modules to receive the shipboard signals. All components of the system are designed to function as PDP-8 peripheral devices, allowing expansion and modification by program changes rather than by hardware redesign.

The place of this data system in the overall information gathering operation is described, and the division of tasks between the shipboard data system and the shore-based reduction programming is developed.

The system described has shown advantages of cost and flexibility, and is expected to be a powerful tool in future weapon system evaluations.

## PLANT WIDE COMPUTER CAPABILITY

James Miller  
Dow Badische Chemical Company  
Freeport, Texas

This paper describes the current application of the computer configuration at Dow Badische which includes a PDP-5, DECtape 555, and 630 Communications System with six remote stations.

The paper begins with a 7-8 minute film describing Dow

Badische and how the off-line digital computer plays a role. The time-shared programming system, which allows all stations immediate access to the computer and a wide selection of programs, is described. The language used to facilitate programming time-shared programs is outlined. The methods to permit remote stations to compile and run FORTRAN programs remotely are also described.

## PROGRAMMING NOTES

### GRAY CODE TO BINARY CONVERSION ON PDP-7

Donald V. Weaver  
Consultant  
New York, N. Y.

```

/      Program I - Full Word Looping Operation
/      lac gray number
/      jms grayco
/      return with AC = binary number

/      requires 110 μsec per conversion
/      occupies 17 words in memory

grayco, 0
         dac gtem
         lam -6      /loop count 6
         dac gctr
         lac gtem
         cll ral     /B0 = G0 in the link

g01,    szl ral     /if Bi = 0, then Bi+1 = Gi+1
         cml
         szl ral
         cml       /if Bi = 1, then Bi+1 = com-
                   /plement of Gi+1

         szl ral
         cml
         isz gctr   /count 3-bit sets
         jmp g01
         jmp i grayco

gtem,   0
gctr,   0

```

/A minimum-space program with one iteration per loop takes /13 words of memory and requires up to 175 μsec per conversion

```

/      Program II - Straightline Operation on 12-Bit
/      Gray Code
/      jms grayto
/      transforms a 12-bit Gray Code number in AC
/      into a 12-bit binary number in applications where
/      Gray numbers are 12 bits or less and time is vital

/      requires 50 μsec per conversion
/      occupies 28 words of memory

grayto, 0
         rtl       /leading zeros
         rtl
         rtl
         spa rtl   /starting algorithm for two
                   /bits

         cml
         szl ral   /ten pairs like this . . .

```

```

cml      /...
:
:
ral      /binary number in AC
jmp i grayto

```

### COMPUTE PARITY AND COUNT BITS

Jon D. Stedman  
Lawrence Radiation Laboratory  
Berkeley, California

```

/      AC $: data word
/      jms parity
/      on entry      AC contains the data word
/      on return     AC is clear and bitc' contains
/                   the binary bit count of the
/                   data word.
/                   link $: 1 if bit count is odd.
/                   link $: 0 if bit count is even.

parity, 0
         dzm bitc' /clear binary bit count
         skp$/cll  /clear parity link initially

par1,   isz bitc   /count bit
         sna
         jmp i parity /exit when all bits clear
         dac parw'
         tad (-0)
         and parw   /clear least significant bit
         jmp pari   /loop

```

## NEWS ITEMS

### NOTES ON THE JOINT USERS GROUP

Richard J. McQuillin  
DECUS Representative to JUG

On October 7-9 a workshop on Programming Language Objectives of the late 1960's was held in Philadelphia, sponsored by SHARE and JUG. The purpose of the workshop was to provide a forum for manufacturers and users to discuss the objectives of programming languages, how present languages meet these objectives, and how these objectives and languages may change to meet future requirements. Emphasis was on emerging concepts such as network computing systems, on-line interactive programming, and data management systems. Among the languages discussed were ALGOL, COBOL, FORTRAN, LISP, SIMSCRIPT, and PL/I. Proceedings of the workshop will be published.

The last meeting of JUG was held at the ACM meeting in Cleveland on August 25. Reports were given on JUG activities on the ASA Standards Committees. In particular, discussion was held on JUG's conditionally affirmative vote on the new proposed revised ASCII codes (prASCII), as well as participation in the ASA X3.4.4 committee on COBOL standardization. Those interested may get more information on these from their JUG representatives.

A brief report was given by an IBM representative on the implementation schedules for PL/I. IBM plans to introduce

several versions of the system, depending on memory size. These are scheduled for delivery between March and September 1966. There would also be a version for time sharing. At each level there would be two compilers: one for quick compiling with rather inefficient object coding; and the other with efficient object coding, but slow compiling time.

Work is proceeding with the publication of the Computer Applications Digest (CAD). This will be a monthly publication of JUG that will give abstracts of current programs and programming systems of the JUG member societies. Costs will be underwritten by the ACM, and publication will soon begin on a trial basis.

The next JUG meeting will be held in conjunction with the FJCC in Las Vegas. All DECUS members are invited to attend.

### DO YOU HAVE A QUESTION?

Due to the success of the Question-and-Answer Session at the Spring DECUS Symposium, the Editor feels that it would be beneficial to users to carry this over as a regular column in DECUSCOPE. The user would submit questions regarding problems he may be having with the software or hardware or any other question he may have regarding DEC Equipment, etc., to the Editor of DECUSCOPE. The questions and their answers received from DEC personnel would be published in DECUSCOPE. Although some questions would only be important to a particular installation, there will be many instances where these questions and answers would benefit other users as well.

In order to get this column "on its way", we ask that you send in your questions as soon as possible. The questions should be sent to: Mrs. Angela J. Cossette, DECUS, Digital Equipment Corporation, Maynard, Massachusetts 01754.

### PDP-6 AND PDP-8 JOIN EMPEROR

#### VAN DE GRAAFF ACCELERATOR

Rochester University's Nuclear Structure Research Laboratory will be installing an on-line time-sharing computer system for experimenting with its new Emperor Van de Graaff Accelerator some time in January. The system will be used for time-shared computation and on-line data acquisition for several nuclear experiments. Major elements of the system are PDP-6 and PDP-8 computers and a new intercommunication subsystem.

The PDP-6, which integrates the equipment and programming needed for time-sharing use, will serve the computation needs of several groups of researchers in the Structure Laboratory and will perform on-line analyses of experimental data taken and sorted on the PDP-8.

The PDP-8 will function in the system as a pulse height analyzer, recording results of subatomic particle interactions induced by the accelerator, sorting the data, and passing it on when required to the PDP-6 for detailed analysis.

A computer was employed for this function instead of a special purpose analyzer because it provides the system with a three-fold flexibility. First, the mode of pulse height analysis can

be simply changed by reading-in a new control program; second, when not in use as an analyzer it can be used in its prime role as a computer; and third, it can also serve as a remote station to the central processor, in this case the PDP-6.

### SPRING 1965 DECUS PROCEEDINGS

The proceedings of the symposium held at Harvard University in May are now available. Copies have been sent to all DECUS delegates. Please direct all requests for copies to Mrs. Angela Cossette, DECUS, Maynard, Mass. 01754.

#### ATTENTION DELEGATES

Please return your ballots for the election of DECUS officers as soon as possible!

## COMPUTER OPTIONS

### MEMORY PARITY

#### TYPE 176

The Type 176 Memory Parity option extends each PDP-7 core memory word from 18 to 19 bits. It provides the hardware for generating and storing parity on transfers to memory and checking parity on transfers from memory. It is completely independent of all parities produced and checked in peripheral devices.

The memory parity option works in the following manner:

1. On transfers to memory, the parity (19th) bit is set so that the sum of 1 bits in the word is odd. This is known as setting "odd parity."

2. On all transfers from memory, a check is made for odd parity. If it is found, no special action is taken. If it is not found, the resulting action is determined by the setting of the three-position switch mounted on the parity logic.

Position 1: Detection of an error in parity will cause the setting of the parity error flip-flop. This flip-flop is connected to the program interrupt facility, the I/O skip facility, and an indicator lamp. If the program interrupt is enabled, a parity error will result in a program interrupt.

Position 2: Detection of a parity error will still cause the parity error flip-flop to be set, but a program interrupt will occur even if the program interrupt control (PIC) is not enabled.

Position 3: Again, the parity error flip-flop will be set, but now the computer will halt at the completion of the current memory cycle. It may be restarted in the usual manner.

3. The parity error flip-flop and associated indicator may be cleared by an IOT instruction or by use of any of the keys except STOP and CONTINUE.



# NEW DECUS MEMBERS

## PDP-5 DELEGATES

Ronald L. Chandler  
Remington Arms Co., Inc.  
Bridgeport, Connecticut

## PDP-5/8 DELEGATES

Gunnar Jungner  
Autokemi AB  
Stockholm, Sweden

Ingemar Jungner  
Autokemi AB  
Stockholm, Sweden

Nils Gottberg  
Autokemi AB  
Stockholm, Sweden

Hans Petterson  
Autokemi AB  
Stockholm, Sweden

Bertil Ugglå  
Autokemi AB  
Stockholm, Sweden

## PDP-8 DELEGATE

Andrew Gabor  
Potter Instrument Co., Inc.  
Plainview, New York

Ole Hestvik  
The Technical University of Norway  
Trondheim, Norway

## INDIVIDUAL MEMBERS

Sergio Ahumada R.  
Centro de Calculo Electronico U.N.A.M.  
Mexico

Tore G. Arbeus  
Telare AB  
Stockholm, Sweden

## INDIVIDUAL MEMBERS (Continued)

William B. Baker  
Phillips Petroleum Co. AED  
Idaho Falls, Idaho

Robert H. Bowerman  
U. S. Naval Underwater Ordnance  
Station, Newport, Rhode Island

Robert M. Boynton  
University of Rochester  
Rochester, New York

John J. Byrnes  
Systems Research Laboratories  
Manhattan Beach, California

Louis D. Coffin  
Battelle - Northwest  
Richland, Washington

T. D. Craddock  
Manitoba Cancer Foundation  
Winnipeg, Manitoba Canada

Fred Feagin  
University of Pittsburgh  
Pittsburgh, Pennsylvania

Jack J. Fishman  
The Foxboro Company, DSD  
Natick, Massachusetts

Harland D. Goodwin  
Phillips Petroleum Company  
Idaho Falls, Idaho

Michael Green  
Case Institute of Technology  
Cleveland, Ohio

Roger A. Hussey  
Northeastern University  
(DSL, Hanscom Field)  
Bedford, Massachusetts

Sven Jansson  
Telare AB  
Stockholm, Sweden

Charles Kapps  
University of Pennsylvania  
Philadelphia, Pennsylvania

## INDIVIDUAL MEMBERS (Continued)

Fred C. Marshall  
Federal Aviation Agency  
Portuguese Bend, California

Carl H. McClure, Jr.  
The Foxboro Company  
Natick, Massachusetts

H. Bjerrum Moller  
Danish Atomic Energy Commission  
Roskilde, Denmark

Lloyd J. Ostiguy  
Inforonics  
Maynard, Massachusetts

James F. Powlowski  
NASA, MSC  
Houston, Texas

Douglas A. Ramsay  
V. A. Hospital, Psychology Svc.  
New York, New York

R. W. Ranshaw  
University of Pittsburgh  
Pittsburgh, Pennsylvania

Martha H. Richardson  
The Foxboro Company  
Foxboro, Massachusetts

Philip B. Sampson  
Tufts University  
Medford, Massachusetts

Robert Sanders  
Sylvania Electronic Products  
Waltham, Massachusetts

Troy L. Williams  
NASA - MSC  
Houston, Texas

Ken Wray  
320 Morgan Cres.  
Kirkfield Park, Manitoba Canada

DECUSCOPE is published monthly for Digital Equipment  
Computer Users Society (DECUS).

Material for publication should be sent to: Mrs. Angela  
J. Cossette, DECUS, Maynard, Massachusetts 01754.

Publications Chairman: Joseph Lundy, Inforonics, Inc.

Circulation: 1,400 copies per month

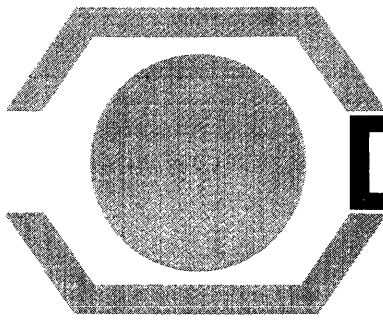

# DECUSCOPE

DIGITAL EQUIPMENT COMPUTER USERS SOCIETY

NOVEMBER-DECEMBER 1965  
Volume 4 Nos. 11 & 12

## DOW-BADISCHE PLANT-WIDE COMPUTER CAPABILITY

James Miller  
Dow Badische Chemical Company  
Freeport, Texas

Dow-Badische Chemical Company manufactures chemical intermediates which include caprolactam, acrylic monomers, and butanol. The plant is located 50 miles south of Houston, Texas, about five miles from the Gulf of Mexico. In 1964, Dow-Badische purchased a PDP-5 computer with 4K memory, a Type 555 DECTape having one dual transport, and a 630 Data Communications System with six remote stations.

A remote station, placed in each control area, provides computer capability throughout the plant and the results have been most satisfying. The distance from the farthest station to the central processor along the route of the cable is one-half mile. Each station consists of one ASR-33 Teleprinter operating on full duplex with reader-stop capability. This requires a six-conductor cable to each station and makes possible FORTRAN compiling, which calls for intermittent tape reading and punching.

Dow-Badische has equipped each teleprinter with a roll-around pedestal which allows the stations to be moved with considerable ease from office to office, or to a control room in the same building.

Periodically an operations man makes a tour of the control instrument area to log in specific items of data such as temperature, pressure, flow rates, composition of streams, and tank levels. Normally, as many as 60 entries are checked to see that the values are within specified limits.

With the aid of the computer and suitable input/output devices, much more information is extracted. An actual survey is made of what has happened since the last set of recorded data, allowing the operations personnel to take action if product distribution is poor. Response is realized over periods of 4 or 8 hours, with such results as:

1. Assurance that the flow of materials into and out of equipment has proceeded as desired.
2. Rapid evaluation of the effect of deliberate process changes.
3. Rapid and exact measurement of the effect of unintentional process changes.

Without the computer such evaluations require tedious hand calculating which is time consuming and cannot be performed more than five times a week.

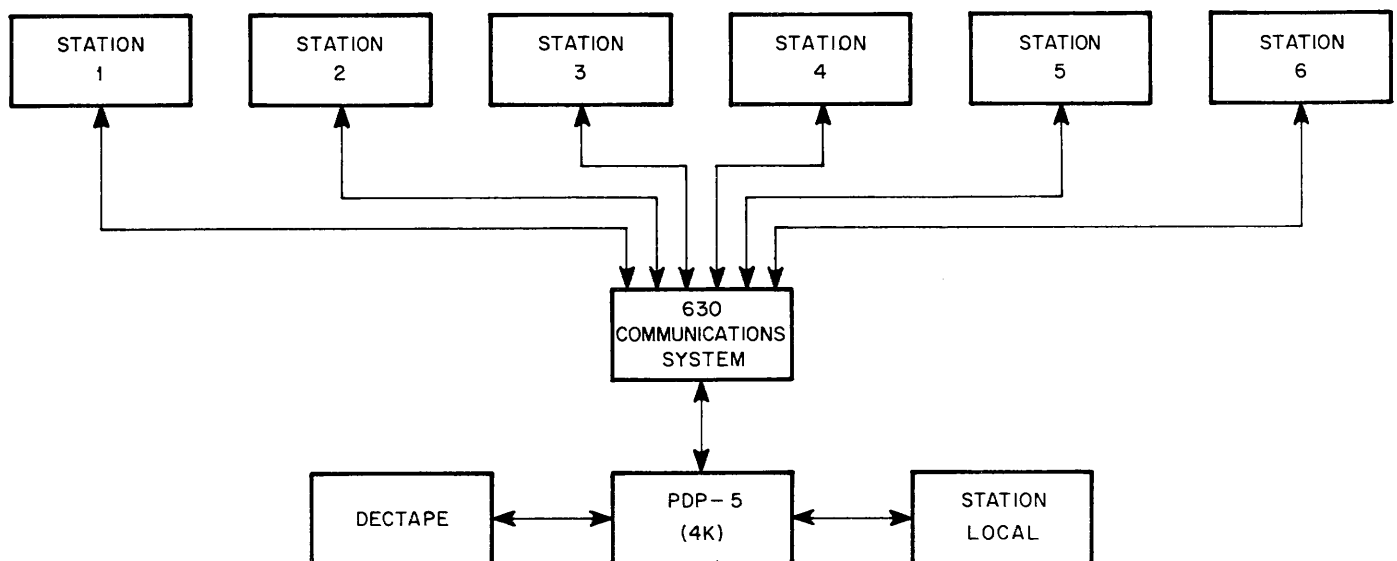

A special time-shared programming system has been developed providing each control area with immediate access to the central processor computer, and allowing ease of interpretation of data by computer users.

### The Time-Shared Programming System

All the double precision mathematical routines are gathered into one compact area along with a text conversion routine and a DECTape write and read routine. The executive routine does not use the interrupt because in this system no main program exists which gathers data or sends information to remote stations. Instead, each teleprinter operates a complete and independent program of its own, with selection of new

programs occurring simultaneously with the operation of other station programs. This system allows each teleprinter 17 msec out of every 100 msec; it also responds to all flags of the DECTape system. Surrender of the computer occurs on input or output functions.

Each station has an area three pages long for its program plus one page which serves to link the station to the common mathematical text and DECTape routines. Programs requiring more than three pages are chained together by calling subsequent portions from DECTape into the same three-page area under program control. No interruption of other programs in progress occurs. Very long programs can be devised in this fashion.

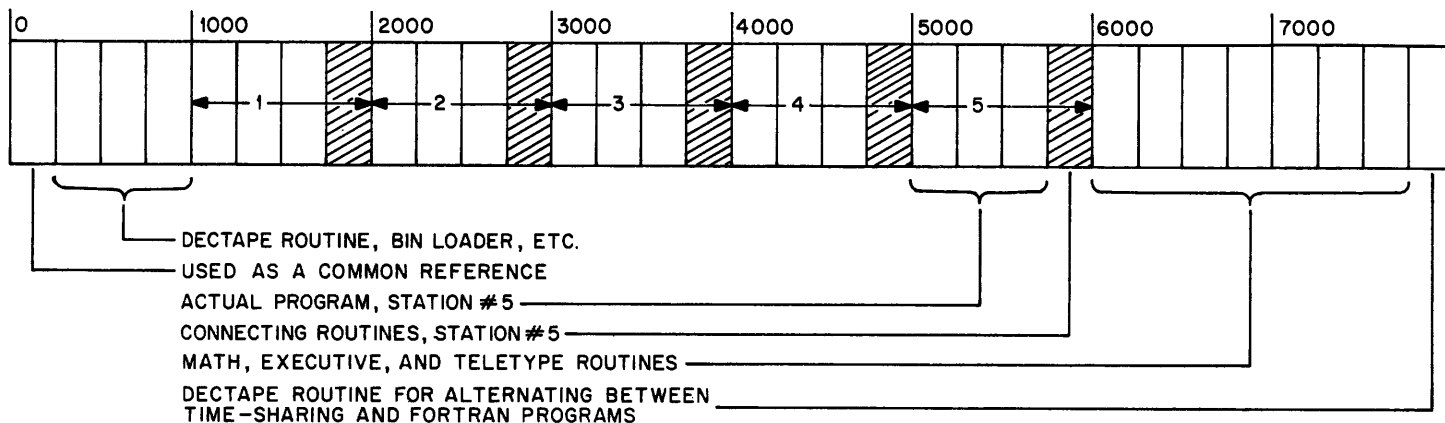

Messages can be sent from one station to another except when a station is on-line.

By means of a special DECTape routine located in the top page of memory, a remote station may take over the entire memory and compile or operate FORTRAN programs in design calculations. This alternating between "remote mode" and "time-sharing mode" is performed without assistance from personnel at the central processor. To prevent serious conflicts a schedule of hours is posted indicating when remote mode is permitted.

By means of the new PAL, a time-sharing "language" was developed. The majority of technical people write programs in this language. Programmers need not understand the details of basic time-sharing and DECTape programming; with PAL III it is possible to store all the pseudo instructions with the assembler, making it easier for the random programmer.

In addition, more than half the salaried technical people and some hourly employees are capable of writing time-shared and FORTRAN programs. This is the result of an intensive programming instruction project developed within the concept of plant-wide computer capability.

### Summary

Some chemical companies have the computer do automatic data logging by tying into direct sensing devices in the plant. Still others "close the loop" by not only sensing data but also executing changes in plant operation under computer control.

The Dow-Badische system has the following advantages:

1. It costs less. It is expensive to convert existing data-gathering equipment from the more conventional air-operated style to digital signal-producing equipment or to provide converters.
2. Dow-Badische processes are constantly being upgraded; the present system demands only simple program changes.
3. The computer makes short-term "brush fire" projects quite simple to undertake. With other more complicated systems, such flexibility is often difficult and at times unavailable.

Briefly, with a total investment of \$70,000, Dow-Badische has placed in five control areas a computer capable of:

1. Routine calculations
2. Routine records keeping
3. Plant performance evaluation
4. Design calculations
5. Additional user's commands.

This paper was presented at the Fall 1965 DECUS Symposium and will also be published in the proceedings of this meeting.

## DECUS FALL SYMPOSIUM EPILOGUE

John T. Gilmore, Jr.  
C. W. Adams Associates Inc.  
DECUS Meetings Chairman - 1965

This symposium, like the one this spring, was scheduled to coincide with the Joint Computer Conference in the same part of the country in order to accommodate those traveling from afar. There seems to be no reason to change this procedure as long as DECUS continues to find gracious hosts at the right places at the right times. It was also the first attempt at a double session, single-day symposium and it appeared to be well received.

Of particular interest was the talk given by guest speaker David R. Brown of Stanford Research Institute on the logical design and implementation of future computers.

The sophisticated use of display scopes for data acquisition and general man-machine communication techniques was most impressive as were the tours of the Stanford Computation Center, the Medical Center and the Linear Acceleration Center.

The delegates meeting was a surprise to many in that it included a discussion of the controversial subject of what to do with symposium papers which describe copyrighted programs which are for sale. The impact of exchanging software for money between users and outside professionals could cause some sweeping changes to DECUS, and it was therefore decided to encourage further discussion of the subject via DECUSCOPE and by a panel discussion session at next spring's symposium.

In summarization, the symposium was another step towards fulfilling the DECUS goal of information exchange.

---

### DECUS BYLAWS REVISED

During the recent election, DECUS delegates voted on several bylaw revisions. All approved revisions have been incorporated into the old bylaws and new sets have been printed and are being sent to all delegates. Individual members and others who would like a copy should contact the DECUS Executive Secretary.

---

### EDITOR'S NOTE

Due to the time spent in preparation of the FALL DECUS SYMPOSIUM, this issue of DECUSCOPE combines the November and December editions. DECUS is growing rapidly, making deadlines that much more difficult to meet. However, our New Year's resolution is publication before the 15th of every month.

## NEW DECUS PUBLICATIONS

Recently, a mailing of the new DECUS Library Catalog was sent to all individual members of DECUS. Those who have applied for individual membership since November 15th will receive their copies shortly.

Delegates will be receiving their catalogs in a new, attractive "DECUS Notebook" which is now being mailed. These notebooks contain information that we feel every delegate should have on hand to effectively keep active his installation in the "users group." Included, for example, is a copy of the revised DECUS bylaws, library catalog, a section for current issues of DECUSCOPE, a DECUS brochure, indexes of past issues of DECUSCOPE and Proceedings, and a list of delegates noting the type of computer each owns. Periodically, material will be sent to update or supplement the information contained within the notebook.

Due to the costs involved in supplying these notebooks, we can only send one complimentary notebook for each computer owned. Additional copies may be obtained at a cost of \$3.00 each. However, if your installation has several PDPs and only one registered delegate, please contact the DECUS office for additional installation applications. Each new delegate will automatically receive a notebook. Non-installation members may obtain copies at \$3.00 each.

We feel these notebooks are another step toward increasing the effectiveness of DECUS. We appreciate receiving your comments and/or suggestions regarding these notebooks.

Please direct requests for copies to the DECUS Executive Secretary, DECUS, Maynard, Massachusetts.

### NEW DECUS OFFICERS

The following are the newly elected DECUS Officers for 1966-67:

President:

John B. Goodenough  
Electronic Systems Division  
Air Force Systems Command  
Hanscom AFB, Massachusetts

Recording Secretary:

Richard G. Mills  
MIT Project MAC  
Cambridge, Massachusetts

Meetings Chairman:

Donald A. Molony  
Rutgers University  
New Brunswick, New Jersey

Executive Secretary (Appointed)

Angela J. Cossette  
Digital Equipment Corporation  
Maynard, Massachusetts



DETAB/65 AVAILABLE FROM  
JUG REPRESENTATIVE

JUG (Joint Users Group) has recently distributed copies of DETAB/65 to the user group representatives. DETAB/65 is a COBOL-oriented decision table language that is designed to reduce complex decision rules to tabular form. When debugging complex programs, detailed coding of decision tables tends to be reduced to careful analysis. The present version of DETAB was developed by Working Group 2 on Decision Tables of the Special Interest Group on Programming Languages (SIGPLAN) of the Los Angeles chapter of the ACM. The following abstract is provided with the package.

"The DETAB/65 preprocessor converts limited-entry decision tables contained within COBOL programs into a form acceptable by a COBOL compiler.

"The preprocessor was designed to facilitate easy modification for various COBOL implementations. It can be used either alone (as a preprocessor) or incorporated into a COBOL compiler.

"The preprocessor has been successfully compiled and executed upon the CDC 1604-A, 3400, 3600, and on the IBM 7040, 7044, and 7090/94 computers.

"The preprocessor package consists of the following:

1. Abstract
2. The DETAB/65 Language
3. A description of the Basic Algorithm used in the DETAB/65 Preprocessor
4. DETAB/65 Users Manual
5. Decision Table Bibliography
6. Preprocessor Card Deck and Listing
7. Test Deck."

Inquiries may be made to the DECUS office.

BEST WISHES FOR YOUR HAPPINESS

IN THE *New Year*



from the  
DECUS Staff

## PROGRAMMING NOTES

### PDP-7 FORTRAN II

#### PROGRAMMING NOTES FOR THE PDP-7

Edmund S. Fine and Daniel J. Gold  
New York University  
University Heights, New York

The following suggestions may be of use to PDP-7 FORTRAN II users.

1. During FORTRAN execution, (i.e., reading and punching of data tapes,) AC switches 9 and 10 placed in the up position indicate ASCII tape input and output; in the down position, FIODEC tape input and output.

2. When inserting a set of S-coded symbolic instructions within a FORTRAN program, be sure that the first instruction is:

```
S [tab] LFM
```

If this precaution is not taken, some of the symbolic instructions may be interpreted as floating point commands which lead to improper execution of the program.

3. In using the 340 CRT Display with FORTRAN, the following sequence may save the programmer from retyping a large section of S-coded symbolic programming.

a. Prepare FORTRAN program with the following sequence at the location where display is desired:

```
S      LFM  
S      JMP DISPLA  
S      GOBACK, NOP
```

b. The symbolic-coded display program should begin:

```
DISPLA, ...  
:  
:
```

and end:

```
JMP GOBACK  
START
```

Note that there is no S in the first field of the entire display tape.

c. The FORTRAN program should be compiled in the usual manner, but the symbolic-coded display section should not be compiled.

d. Read the FORTRAN compiler output tape into the Symbolic Tape Editor. Delete "START" which is at the end of the tape, and punch out the corrected tape.

e. Assemble the tapes together using the FORTRAN Assembler, reading the Editor-corrected FORTRAN compiler output in first.

f. Continue from here according to the normal FORTRAN procedure.

Communication between the segments may be easily achieved through the use of integer variables as described in the FORTRAN II MANUAL, DIGITAL-7-2-S. This general procedure may also be used for other symbolic-coded program segments.

### PDP-7 PARITY TEST/GENERATE PROGRAMS

Donald V. Weaver, Consultant  
New York, N.Y.

Some Teletype devices punch even parity in channel 8 of ASCII code. The program to verify input parity is modified to generate parity on output.

#### Program I Full Word Looping Operation

```

/      jms parity
/
/      each bit of contents of AC is rotated into the link
/      where a modulo2 sum of previous bits is half-added
/      to it; any character length may be used; program
/      iterates until AC is clear
/
/      requires under 50 μsec on 8-bit ASCII code

parity, 0
cll rar      /sum is zero initially
szl cll rar  /0+bi = bi
cml         /1+bi = bi complemented
sza
jmp .-3
szl
jmp error   /or, tad C200
jmp i parity

```

Note that final skip-test and next instruction are "parameters" of the program generator:

1. Reverse sense of skip for odd parity test.
2. Select desired action by next instruction--stop on input disparity or generate output parity.
3. Instead use isz parity in an all-use program with standard procedures for a "dual return."
4. If processing both types of parity, leave skip-test and action for main program.

#### Program II High Speed Operation on 8-bit ASCII Code

```

/      executes in 20 to 30 μsec per 8-bit ASCII code re-
/      quires 19 words of memory

parity, 0
cll rar
szl cll rar  /event times 1, 2, and 3
cml
:
:
szl cll rar  /seven pairs like this
cml
szl
jmp error   /or, tad C200; or, isz parity
jmp i parity

```

See note at end of Program I

## PROGRAMMING MEMORANDUM CHANGE IN PDP-8 MEMORY EXTENSION

D. A. Campbell  
The Foxboro Company  
Natick, Massachusetts

DEC has recently made a change in the operation of the CDF (Change Data Field) instruction on the PDP-8. The current data field is used as part of the memory referencing address only after a deferred cycle (i.e., if the instruction is an "indirect"). Otherwise, the current instruction field is used as the high-order portion of the address.

This was not true on the PDP-5 which always used the data field for the address. While this modification allows more efficient coding (as shown in the example) many PDP-5 routines which are not coded to obtain information directly from another memory bank do not work properly on the PDP-8.

#### Example 1 PDP-5 Coding (Instruction Field=1; Data Field=1)

```

tag,   cdf 0      /switch to data field 0
      tad z 1     /get bank 0 info
      cdf 10     /back to bank 1
      dca temp1  /store in bank 1
      cdf 0      /back down to get
      tad z 2     /a second word
      cdf 10
      dca temp2
      ::::

```

#### Example 2 New PDP-8 Coding (Instruction Field=1; Data Field=1)

```

tag,   cdf 0      /switch down
      tad i a1    /get thru indirect
      dca temp1   /12-bit address
      tad i a2
      dca temp2   /"directs" store in
      cdf 10     /instruction field bank
      ::::
a1,    1          /12-bit addresses
a2,    2
temp1, 0          /temporary storage
temp2, 0

```

## USING STANDARD RIM OR BINARY LOADERS FOR MULTIBANK LOADING IN THE PDP-8

D. A. Campbell  
The Foxboro Company  
Natick, Massachusetts

#### Reference: Change in PDP-8 Memory Extension

Because of the modification in the CDF (change data field) function on the PDP-8, any standard DEC RIM or Binary Loaders will load into any 4K bank of core memory with proper manipulation of the console switches. Operate the desired loader in the standard manner with the following exceptions:

1. Set the memory bank in which the loader is located in the instruction field switches only.
2. Set the bank required to load the tape in the data field switches.

3. Press LOAD ADDRESS key and START
4. Program tape will be loaded into the bank designated in the data field switches.
5. To load another tape into the same bank, press CONTINUE. To load a tape into another bank, reset data field switches and reload address.

This concept will work with other types of programs (such as the Core Memory Search program, etc.) provided the program occupies only one core page (i.e., does not communicate between core pages with internal indirect references other than JMP or JMS) using indirect references only to obtain or store information external to the program when multibank access is desired.

### PARITY COMPUTE/TEST/GENERATE PROGRAMS FOR PDP-8

Donald V. Weaver, Consultant  
New York, N.Y.

The PDP-8 lacks a micro-operation to set skip-and-rotate in a single cycle like the PDP-7's unique routine

```
szl cll rar /PDP-7
cml
```

which is the kernel of an ultra-fast program to test and/or generate parity on the PDP-7. However, the PDP-8 can simulate this action by:

```
rar /PDP-8
spa
tad MI /=400
```

Iterating this sequence erases each 1-bit in the AC and adds it into a modulo 2 sum in the link, for parity determination of characters punched on paper tape in the ASCII even-parity format of new Teletype devices.

The small kernel of this loop and loop control without a counter suggests it may be used in-line to compute parity in special applications:

```
cll
rar
spa
tad MI /=4000
sza
jmp .-4
```

The following subroutines are provided for general use.

#### Program I Full Word Looping Operation

```
/ jms parity
/ requires 40 to 70 μsec on the 64-character data
/ set in ASCII
parity, 0
cll rar
rar /channel 2, 3, ... in the link
spa
tad MI /=4000
sza
jmp .-4
szl /or snl for odd parity test/generate
isz parity /or, jmp error; or, tad C200
jmp i parity
```

The final skip-test and non-skip action on leaving the loop are parameters in a program generator:

1. Reverse the sense of the skip to test for odd parity tape.
2. Use isz parity in a dual-use program with dual return to actions specified in the main program.
3. Select desired non-skip action by this instruction in a specialized program. Stop on input disparity or generate output parity.
4. Omit these instructions if desired in processing both odd and even parity tapes, placing them in the main program.

#### Program II Highspeed Straightline Operation

The great majority of ASCII data characters contain four or more 1-bits, so that a straight-line operation, omitting spa in high-volume applications, gives efficient results.

```
/ jms parity
/ requires 40 μsec plus or minus one cycle on any
/ 8-bit code occupies 18 words in memory plus 1
/ constant
parity, 0
cll rtr /channel 1 in AC0
tad MI /=4000
rar /six pairs like this...
tad MI /...
:
szl cla /or, snl for odd parity test/generate
isz parity /or, specific action
jmp i parity
```

See note at end of Program I

#### Program III Specialized Program

The final stage of rar, tad MI (Program II above) is not needed in a special program to generate parity for compatible tapes since the raw code contains no more than 7 bits.

```
/ jms pargen
/ occupies 16 words
/ requires 35 μsec plus or minus one cycle to complete the action
pargen, 0
cll rtr /channel 1 in AC0
tad MI /=4000
rar
tad MI
rar
tad MI
rar
tad MI
rar
tad MI
rar
tad MI
szl cla
tad C200
jmp i pargen
/end
```

# DECUS PROGRAM LIBRARY

## PDP-5 PROGRAM LIBRARY ADDITIONS

### DECUS No. 5-1.1

Title: BPAK - A Binary Input-Output Package for the PDP-5

Author: P.T. Brady, New York University

This is a revision of the binary package originally written by A.D. Hause of Bell Telephone Laboratories (DECUS No. 5-1). With BPAK the user can read in binary tapes via the photoreader and punch them out via the Teletype punch. It may be used with any in-out device, but is presently written for the photoreader and Teletype punch. A simple modification, described in the write-up, converts BPAK so that it reads from the Teletype reader if the photoreader is disabled. In its present form it occupies locations 7600-7777 and incorporates these features:

1. Readin of BIN or RIM tapes with checksum verification, Teletype-character-ignore-provision (so that PAL error codes will be ignored), and ejection of the end-of-tape from photoreader. Entry is load address 7777; START.
2. "Verify" mode, which is identical to readin except that the program is not stored in memory. This is very useful in checking on correct punch-out of tapes (via the checksum) without spoiling the stored program.
3. Punchout in either RIM or BIN format. Checksum may be punched when desired. Use of readin mode will not affect punchout checksum.

### DECUS No. 5-2.1

Title: OPAK - An On-Line Debugging Program for the PDP-5

Author: P.T. Brady, New York University

OPAK (octal package) is a utility program which enables the user to load, examine, and modify computer programs by means of the Teletype. This program is a revision of the program written by A.D. Hause, Bell Telephone Laboratories (DECUS No. 5-2). Extensive use of the program has suggested many refinements and revisions of the original program, the most significant additions being the word search and the breakpoint. The standard version of OPAK is stored in 6200 to 7577 and also 0006. An abbreviated version is available (7000 to 7577, 0006) which is identical to the other except that it has no provision for symbolic dump. Both programs are easily relocated. Control is via Teletype, with mnemonic codes, (e.g., "B" for inserting breakpoint, "P" for proceed, etc.). This program includes:

1. Single or multiple register examination in symbolic or octal.
2. Single or multiple register loading in octal.
3. Breakpoint with accessible accumulator and link.

4. Block shifting of words in memory, which also allows filling up blocks with a single word.
5. Word search with mask, output in symbolic format.
6. Symbolic dump which includes:
  - a. variable format controlled by switch register
  - b. type out of effective addresses on all instructions
  - c. ability to recognize seven in-out device groups
  - d. trim-code interpretation of word (SR option).
7. All dumps are interrupted by striking any Teletype key, allowing rapid termination of any dump without using computer console.

### ADDITIONAL FEATURES IN OPAK

Two new features have been added to OPAK (both OPAK regular and abbreviated) which should make its operation slightly easier. The manner of using OPAK is virtually unchanged. The new features are:

1. There is no longer a need to type initial zeros. If you wish to examine register 0207, simply type 207E $\mathcal{X}$ . The symbol  $\mathcal{X}$  denotes space. If you wish to store 0000 into some register when loading data, type one zero. Numbers are still right-adjusted. If only a space or comma is typed, the register is left alone.

Previously, if a nonoctal character was typed in load mode, it was ignored. Now nonoctal characters are illegal (except for space and comma), and if typed will cause an immediate reentry of the "E" mode. In the following example X represents any nonoctal character.

4000L 3523X4000=3523

Also,

4320E 4320=7021 4334E4320=4334

2. Whenever OPAK is in keyboard listen mode, the accumulator will contain the following information:
  - a. No breakpoint in effect, AC=0.
  - b. Breakpoint in effect, AC=breakpoint location.

It is possible at a glance to determine OPAK's breakpoint status.

The insertion of the above features required extensive revision of memory locations 7000-7377. A new symbolic dump has been prepared. The remainder of OPAK is unchanged, except for 7576 and 7577.

The Dice Game written by E. Steinberger, Digital Equipment Corporation, has been revised to operate on either the PDP-5 or PDP-8, and makes use of the program interrupt facility.

DECUS No. 5/8-27

Title: ERC Boot  
Author: L. J. Peek, Jr., Western Electric, Princeton, New Jersey

The ERC Boot is a bootstrap routine somewhat simpler than the one presently available for the PDP-8. This routine restores the entire last page, consisting of:

1. a Clear Memory Routine,
2. RIM Loader and,
3. Modified Binary Loader.

The Clear Memory routine is entered at 7600 (octal). It clears (to 0000) the lower 31 pages of memory, then branches to the Binary Loader.

The modified Binary Loader halts after reading tape with the checksum in the accumulator. If the binary tape is properly terminated, pressing CONTINUE takes a branch to the beginning location of the program. PAL compiled programs may be properly terminated by ending the PAL symbolic tape in the following manner:

P  
A  
L  
S  
Y  
M  
B  
O  
L  
I  
C  
P  
R  
O  
G  
R  
A  
M

\*START (any named starting address)  
\$

The Binary Loader stores the octal value for START in the location labeled ORIGIN in BIN. The instruction following HLT in BIN is replaced by JMP I ORIGIN (5616), causing a branch to START.

Instructions for the bootstrap operation are as follows: Toggle in the instructions beginning at 0030.

0030	Load Address
7404	Deposit
6036	Deposit
7012	Deposit
7010	Deposit
3025	Deposit
2034	Deposit
5030	Deposit
0030	LOAD ADDRESS
	START

Place the tape in the ASR33 reader with pins under the first character.

Turn reader to ready.  
Press CONTINUE four times.

When reader stops, entry may be made at 7600 (to clear memory), or in normal fashion to RIM or BIN.

## NEWS ITEMS

### PDP-8 COMPUTER CONTROLLING 150-FOOT STANFORD ANTENNA

A computer-controlled system which aims a 150-foot parabolic antenna at signal sources in the sky has been developed by the Radio Physics Laboratory of Stanford Research Institute.

The antenna is used for space and astronomy experiments by scientists from Stanford Research Institute and Stanford University. The studies include radio and radar astronomy, communications, and satellite tracking.

The heart of the control system is a PDP-8. The computer generates signals derived from commanded scanning patterns to home the antenna precisely on its target.

Included in the system with the PDP-8 are its console teletypewriter, a high-speed perforated tape reader by which pointing ephemerides are loaded, a 4096-word core memory where they are stored, and two digital-to-analog converters supplying output signals to the antenna servo system.

### UNIVERSITY OF AACHEN USING PDP-6 IN HIGH ENERGY PHYSICS RESEARCH

The Physics Department of the Technical University of Aachen is using a PDP-6 computer to control a system analyzing data in high energy physics research.

The data is contained in photographic films showing tracks of high energy particles interacting in the liquid of a bubble chamber. To facilitate rapid and precise coordinate measurements of tracks in a large sample of events, a set of six digitized projectors are connected on line to the PDP-6 system. This allows operators to immediately check and analyze the measured data at each of the six devices. By appropriate messages the operators are told which events to measure and, in case of an error, when to repeat the measurements. An appreciable gain in accuracy and speed is expected, compared to conventional off-line measuring techniques.

The PDP-6 consists of arithmetic processor and console teletypewriter, 32,768-word core memory, 200-card-per-minute reader, 300-line-per-minute printer, data control, dual DECtape transports and control, two industry-compatible magnetic tape transports and control, and a data communication system with six remote input/output stations.

Other physics research using the PDP-6 in on-line particle interaction studies and in automatic film-reading is being conducted at the University of Bonn and at Massachusetts Institute of Technology. The computer's time-sharing applications include a centralized computing service for use simultaneously by many scientific and engineering staff members at the Rand Corporation in California.

### SCIENTISTS DEVELOP HIGH-SPEED DATA ACQUISITION SYSTEM

A high-speed data acquisition system has been developed by scientists at Battelle-Northwest, Richland, Washington, for initial use in a planned series of nuclear reactor containment system experiments.

The system, or multianalyzer, will serve as a high-speed data logger and pulse height analyzer in work being performed at the Pacific Northwest Laboratory which Battelle operates for the Atomic Energy Commission.

Included will be a PDP-7 computer, console teleprinter, 4096-word memory, analog-to-digital converter, oscilloscope display, and Dual DECtape transport and control built by Digital Equipment Corporation. Battelle scientists and engineers are adding special purpose equipment to complete the overall multianalyzer system.

## COMPUTER OPTIONS

### PDP-8 CONTROLS NEW SYSTEM FOR COMMUNICATION SWITCHING

An economical new switching system, the Type 680 Data Communication System controlled by a PDP-8, was introduced by DEC for use in communication systems and computation centers. It can function independently as a complete line scanning control, or it can serve as a peripheral device to bunch inputs and outputs for most efficient use of large central processors.

In the message switching function, the computer scans up to 128 lines--sequentially or in a commanded order--accepting incoming messages one bit at a time, assembling the bits into characters, storing the characters, and routing them--again one bit at a time--to their destinations.

The basic difference between the 680 and other systems is in their methods of buffering characters. Other systems have used active registers--flip-flops--for this function. The 680 System uses magnetic core registers in the memory of the PDP-8. The 680 concept is basically more economical and reliable and it offers greater flexibility than the earlier systems lacked.

The reliability advantage results from using the core registers in place of the active flip-flop registers, which are more prone to failure. Since memory can be checked automatically as part of the regular maintenance of the computer, potential failures can be prevented.

An example of the added flexibility provided by the new switching concept is the 680's ability to deal with lines of different speeds and character sizes, with no wiring changes needed to mix lines and change their operating characteristics.

Economy results from eliminating the large numbers of flip-flops. In an eight-level code system, 17 flip-flops would be required for each line, eight on the line side and eight on the computer side for data and an additional one to show line status. Others are required for control signals.

In earlier Teletype line scanning systems supplied by DEC as many as 48 lines have been used, each requiring at least 17 flip-flops, plus mounting equipment, wiring, and power supplies.

### NEW SOLID-STATE TAPE TRANSPORT TYPE TU55

A simple, solid-state magnetic tape drive for use with the PDP-7 and PDP-8 computers has been developed by DEC. The DECtape Type TU55 Transport has a reliability figure of less than one transient error per  $10^{10}$  characters.

The TU55 consists of two guides which float the tape over the read-write head, dual direct-drive hubs, motors with integral electromagnetic brakes, solid-state circuits feeding power to motors and brakes, and front-panel switches for manual control and check-out.

As in earlier DECtape drive units, no pinch rollers, capacitors, mechanical buffering, or vacuum columns are needed to control tape motion. Tape tension is controlled electromagnetically.

The TU55 differs from earlier DECtape transports in two major respects: replacement of relay control components by solid-state devices, and elimination of one of the usual two transports. The prime feature of the TU55 is its low cost in comparison to other tape transports.

The new transport, like earlier models, is designed for use with a control unit which segments computer words before recording them and reassembles them when reading back to the computer. The transport uses the same 4-in. reels containing 260 ft. of 3/4-in. Mylar sandwich tape. Recording density is  $350 \pm 55$  bpi, and read-record speed in either direction is  $97 \pm 14$  ips. Total information capacity per reel is  $2.7 \times 10^6$  bits, arranged in duplexed 3-bit characters.

A principal application for the new transport is serving as economical bulk storage of data and programs in small computer systems lacking disc, drum, or conventional magnetic tape subsystems.

DECUSCOPE is published monthly for Digital Equipment Computer Users Society (DECUS).

Material for publication should be sent to: Mrs. Angela J. Cossette, DECUS, Maynard, Massachusetts 01754.

Publications Chairman: Joseph Lundy, Inforonics, Inc.

Circulation: 1,400 copies per month

# NEW DECUS MEMBERS

## PDP-1 DELEGATE

Richard W. Conn  
Lawrence Radiation Laboratory  
Livermore, California

## PDP-5 DELEGATE

Donald R. Machen  
Lawrence Radiation Laboratory  
Berkeley, California

## PDP-6 DELEGATE

Anthony Yonda  
University of Rochester  
Rochester, New York

## PDP-7 DELEGATES

J. R. Bird  
A.A.E.C. Research Establishment  
Sutherland, NSW Australia

Curtis W. Coleman  
University of Michigan  
Ann Arbor, Michigan

N.P. Wilburn  
Battelle-Northwest  
Richland, Washington

## PDP-8 DELEGATES

D. W. Beard  
Picker X-Ray Corporation  
Cleveland, Ohio

R. L. Beddoes  
Hilger & Watts Limited  
London, N.W. 1, England

Milton Collins  
Teradyne Incorporated  
Boston, Massachusetts

Paul F. Doering  
General Railway Signal Company  
Rochester, New York

M. S. Elzas  
Applied Dynamics Europe  
Rotterdam, Holland

D. Laurent  
Laboratoire Chimie Organique Physique  
Paris, France

Terrel L. Miedaner  
University of Wisconsin  
Madison, Wisconsin

G. Oberski  
Institute for Nuclear Physics Research  
Amsterdam, Netherlands

## PDP-8 DELEGATES (continued)

Mr. Pellier  
Center for Bioclimatic Studies  
Strasbourg, France

William F. Raub  
University of Pennsylvania  
Philadelphia, Pennsylvania

Gerald A. Sabin  
USN Underwater Sound Reference Lab  
Orlando, Florida

Pierre Vauthieu  
SINTRA  
Asnieres (Seine), France

## LINC DELEGATES

C. Alan Boneau  
Duke University  
Durham, North Carolina

Louis Siegel  
Univ. of Rochester School of Medicine  
Rochester, New York

## 340 DISPLAY DELEGATE

George A. Bain  
USN - Underwater Ordnance Station  
Newport, Rhode Island

## INDIVIDUAL MEMBERS

Boyd R. Borrill  
Brookhaven National Laboratory  
Upton, New York

Earl H. Brazeal, Jr.  
United Aircraft Research Laboratories  
East Hartford, Connecticut

Stewart C. Davis  
USN - Underwater Ordnance Station  
Newport, Rhode Island

Daniel J. Edwards  
M.I.T. Project MAC  
Cambridge, Massachusetts

Stanley Habib  
Bell Telephone Laboratories  
Holmdel, New Jersey

Anthony James Hance  
Stanford University Medical School  
Palo Alto, California

T. A. Henriquez  
USN Underwater Sound Reference Lab.  
Orlando, Florida

## INDIVIDUAL MEMBERS (continued)

Ed. J. Jung, Jr.  
NASA  
Houston, Texas  
P.U. Ten Kate  
Institute for Nuclear Physics Research  
Amsterdam, Netherlands

Douglas A. Kent and  
Jon Kiiskinen  
Lawrence Radiation Laboratory  
Berkeley, California

Daniel Lee  
Jet Propulsion Laboratory  
Pasadena, California

Philip Loe  
Univ. of Maryland School of Medicine  
Baltimore, Maryland

John F. McNall  
University of Wisconsin  
Madison, Wisconsin

William W. Norris  
United Aircraft Research Laboratories  
East Hartford, Connecticut

David Ophir  
Brookhaven National Laboratory  
Upton, New York

Jeremy D. Pollack  
Rutgers University  
New Brunswick, New Jersey

Frank Stubenitsky  
University of California  
Berkeley, California

Thomas Taussig  
Lawrence Radiation Laboratory  
Berkeley, California

Joel Tenenbaum  
Harvard Cyclotron Laboratory  
Cambridge, Massachusetts

Norman E. Turner  
Teradyne Incorporated  
Boston, Massachusetts

I.C. Walker  
AERE Harwell  
Didcot, Berkshire, England

Peter S. Weiss  
Brookhaven National Laboratory  
Upton, New York

Stacy E. Wise  
Battelle-Northwest  
Richland, Washington

William S. Yamamoto  
University of Pennsylvania  
Philadelphia, Pennsylvania